



NSPCC

Reunification

An Evidence-Informed Framework for
Return Home Practice

Mandy Wilkins and Elaine Farmer

In partnership with



EVERY CHILDHOOD IS WORTH FIGHTING FOR

Published by the NSPCC 2015

British Library Cataloguing in Publication Data

ISBN 978-0-9560194-4-8 (paperback)

ISBN 978-0-9560194-5-5 (pdf)

Copies of this Framework are available at

<http://www.bristol.ac.uk/sps/research/projects/completed/2016/returninghome/>

and

www.nspcc.org.uk/returninghome

© NSPCC and University of Bristol 2015. Photography by Jon Challicom. The adult and child pictured are models. You may use this publication for your own personal, non-commercial use and otherwise in accordance with the Copyright Designs and Patents Act 1988 only. No part of this publication may otherwise be copied or reproduced without prior written permissions. NSPCC is a registered trade mark. All rights acknowledged and reserved. Whilst we have made every effort to ensure the accuracy of this publication, we cannot guarantee it and you should not rely on the contents of this publication. Registered charity England and Wales 216401. Scotland SC037717.

Contents

Acknowledgements	5
Introduction	7
Where does the Framework fit and how can it be used?	7
Key message for strategic leaders	8
Key messages for practitioners and team managers	8
When to use the Practice Framework?	9
Why did we develop the Framework?	11
What is included in the Framework? The approach and contents	13
Who can deliver the Practice Framework?	17
Principles underpinning the Practice Framework	18
The Return Home from Care Practice Framework	21
Stage 1: Assessment of risk and protective factors and parental capacity to change	23
Stage 2: Risk classification and decision on the potential for return home	37
Stage 3: Parental agreements, goal setting, services and support and continuing the assessment of parental capacity to change	45
Stage 4: Reclassification of risk, decision-making and planning for reunification	57
Stage 5: The return home	63
References	67
Annexes: Tables and Templates	
Annex 1: Definitions of risk & protective factors	72
Annex 2: Accessible version of Risk Classification Table for children and parents	79
Annex 3: Chronology template, top tips and case study	80
Annex 4: Basic genogram components	83
Annex 5: Return Home Assessment Report Template	85
Annex 6: Young Person's Report	91
Annex 7: Written Parental Agreements	93
Annex 8: Setting and Reviewing Goals	96
Annex 9: Reunification Plan Template	98
Annexes: Additional Guidance	
Annex 10: Amended Care Planning Regulations and Guidance for Children Ceasing to be Looked After	99
Annex 11: Case eligibility and fit with court timescales	103

Annex 12: Tips for working with children and young people	104
Annex 13: Special considerations when assessing return home from care in relation to babies	106
Annex 14: Assessing risks and protective factors and planning for positive outcomes for adolescents in relation to return home care	108
Annex 15: Case study showing the impact of the assessment for young people who 'walk themselves home'	112
Annex 16: Engaging parents	113
Annex 17: Parents with learning disabilities	114
Annex 18: Top Tips for assessment	115
Annex 19: Assessing parental capacity to change	116
Annex 20: Neglect	120
Annex 21: Additional guidance for working with families where reunification will not be possible	121
Annex 22: Families who experience multiple removals of their children	122
Annex 23: Example of later life letter	123
Annex 24: Case supervision for the Practice Framework	125

Acknowledgements

The authors would like to acknowledge and thank all those who have contributed their experience, insight and expertise to the writing of this Framework. This includes the NSPCC and local authority teams who have delivered and continue to deliver the Framework, and who have taken part in the evaluations. Thank you to Georgia Hyde-Dryden, Lisa Holmes, Doug Lawson and Jenny Blackmore from Loughborough University for writing the evaluation report on the first edition of the Practice Framework. We thank those parents, young people and children who have taken part in the evaluation, and whose views have shaped the writing of this Framework. Thanks also to Camelia Borg for her insight and support.

Particular acknowledgement and thanks must go to Harriet Ward and Rebecca Brown from The Centre for Child and Family Research at Loughborough University who worked with NSPCC in 2012 to develop the original Reunification Practice Framework.

Thanks are owed to the following NSPCC staff who authored and advised on specific sections of the Framework: Saira Bashir, Karen Bates, Karen Bateson, Louise Bazalgette, Joseph Davenport, Julian Fabian, Damien Fitzpatrick, Dawn Hodson, Anna Holland, Di Hunter, Helena Jones, Wilma King, David Matthews, Sophie Michaelides, Tom

Rahilly, Gwynne Rayns, Tracey Swithenbank, Steven Tait and Beth Willoughby. Thank you also to Carlene Firmin for advice about adolescent risk.

The Framework has also been reviewed by the following academic experts who all contributed valuable insights and suggestions: Professor Janet Boddy, University of Sussex; Dr. Dendy Platt, University of Bristol; Professor June Thoburn, University of East Anglia; and Jim Wade, University of York.

Thanks to Judith Fisher from Regent Typesetting for making this Framework clear and easy to navigate.

This report was produced by the University of Bristol in partnership with the NSPCC and funded by the Department for Education.

The views that are expressed in this work are those of the authors and do not necessarily reflect those of the Department for Education.

The Department for Education also funded a report by the National Children's Bureau and The Centre for Child and Family Research, University of Loughborough exploring current local authority practice in relation to reunification. The report, *Improving practice in respect of children who return home from care: research report* (Hyde-Dryden et al 2015a) can be found here: www.lboro.ac.uk/research/ccfr

A note on terms

The term 'looked after children' includes children who are the subject of a care order, and those accommodated under Section 20. We use the terms 'entry to care' and 'return home from care' to include **all** looked after children, not only those who are subject to a care order.

Views of local authority staff on the Practice Framework

“The Framework is excellent and easy to follow – It is a practical tool with real relevance to the lives of children.”

Social Worker

“It goes back to ‘proper’ social work.”

Social Work Team Manager

“The quality of assessment, care planning, recording and paperwork has improved significantly.”

Head of Service

“Really high level of research; really well presented document, and it really does stand up to a lot of scrutiny.”

Senior Manager

Views of parents and young people

“It’s different from past assessments ... a lot better ... gives you more of a chance.”

Parent

“After what I went through I am so pleased that you are doing this work to help other children and young people returning home from care.”

Young person

“My children got on really well with the social workers who definitely took account of their views.”

Parent

Introduction

“Return home from care hasn’t received the attention it deserves, and we welcome the spotlight being turned on it”

(Andrew Christie, Executive Director of Tri-Borough Children’s Services and Chair of the Association of Directors of Children’s Services Health and Social Care Policy Committee)

Where does the Framework fit and how can it be used?

The Practice Framework was written as a response to research findings about the **recurrence of maltreatment and poor outcomes for children returning home from care**. Research has shown that failed reunifications are associated with poor practice – including lack of, or limited, assessments and inadequate support for children and families before and after reunification. The Framework therefore aims to **fill a gap in current practice guidance** for practitioners in England. It draws together the **key messages from reunification research** into a practical guide to support practitioners working with children and families in and on the edges of the looked after system.

The Framework supports local authorities to fulfil their duties under the **Children Act 1989, the recently amended Care Planning Regulations and Guidance, and the revised Working Together 2015 Guidance**^{1,2,3}. Annex 10 provides the relevant sections of the regulations and guidance relating

to reunification. As such, the Framework is designed to fit with existing local authority duties and practice in relation to care planning for looked after children and for those who cease to be looked after.

The Framework also links with **Ofsted’s Single Inspection Framework** in which inspectors examine cases of children who have returned home, and those for whom a return home is planned. The NSPCC has trained HMI staff on the research and practice which underpins this Framework; the messages from research about reunification success and breakdown, and the characteristics of good and concerning practice that inspectors should identify and scrutinise.

This Framework is not statutory guidance – it is a resource that local authorities can use to support practice improvements for children returning home from care. The Framework supports practitioners and managers to apply **professional judgement** to complex decisions about whether a child should return

1 http://www.legislation.gov.uk/uksi/2015/495/pdfs/uksi_20150495_en.pdf

2 <https://www.gov.uk/government/publications/children-act-1989-care-planning-placement-and-case-review>

3 https://www.gov.uk/government/uploads/system/uploads/attachment_data/file/419595/Working_Together_to_Safeguard_Children.pdf

home from care and what support will be needed to ensure that reunification is safe and successful. It provides a structure for analysing risks to the child, based on robust evidence. It supports families and workers to understand what needs to change, to set goals, access support and services and review

progress. The approach to assessment and delivering support outlined in the Framework should build on and complement the existing work that practitioners are already doing with these children and their families, not replace it.

Key message for strategic leaders

The NSPCC has worked with 14 local authorities to develop and implement the Framework since 2012. One of the clearest messages from this work is the need for **senior leadership and commitment** to a **whole authority approach** to improving practice in this area. Whilst the Framework focuses on frontline practice, there are many areas for senior managers to consider which will support successful implementation. These include workforce development, quality assurance, resources, identifying and commissioning services where there

are gaps, multi-agency working and understanding costs. To support strategic leads we have developed an **Implementation Checklist** which can be found here – www.nspcc.org.uk/returninghome and here – <http://www.bristol.ac.uk/sps/research/projects/completed/2016/returninghome/>

Further information about the findings and messages from implementation can be found in the evaluation, which is also available on the websites above.

Key messages for practitioners and team managers

The Framework describes good social work practice in the specific context of reunification work. As such, the content including the skills, knowledge and tasks, will be familiar to social work and social care professionals. The additional benefit of the Framework is that it applies the key messages from reunification research⁴ to social work practice.

⁴ The research cited has been selected to signpost some of the key sources of reference to the research findings which inform the Framework. Inevitably it is not exhaustive and particular prominence has been given to more recent UK research and research reviews. The Framework has also been informed by a broader literature review on reunification which includes more of the international literature. The evaluation findings suggested that some key research findings were not well known in the field and we have tried to give them greater emphasis in this revised version of the Framework.

When to use the Practice Framework?

Many of the children and families to whom the Framework applies will already be known to children's services. They will be involved in ongoing assessment and support work, and the Framework is designed to build on this. Social workers using the Framework will be sensitive to children and families' past and present experiences of intervention, support and services, and of the impact on the wider family of the child becoming looked after. It is intended that the Framework is used to help practitioners assess **whether or not** reunification is the best permanence option for a child.

The Framework may be used when:

- a local authority is **considering that a child may need to become looked after**. In these circumstances the local authority may use elements of the assessment and risk framework to inform the decision about whether a child can remain safely at home with support or whether a short period of accommodation (under s20) will better support the child and their family.
- **a child is on the edge of care and in pre proceedings**
- **a child is accommodated under Section 20 of the Children Act 1989**

In these circumstances a child may return home to their family as the result of care planning or in an unplanned way due to the child or parent deciding to end a placement. It is important to acknowledge that practitioners are not always able to make the decision about when a child returns home to their family. Parents retain parental responsibility when a child is accommodated under Section 20. Sometimes a parent or child will pre-empt what the practitioner is planning. Messages from research and practice highlight that practitioners often feel that 'nothing can

be done' when a young person returns home of their own accord.⁵ However, as the reunification breakdown rate for adolescents is high, and those children who oscillate in and out of care experience the worst outcomes⁶, there needs to be a more pro-active practice response. The Framework provides a structure for practitioners when a parent and/or a child ends the Section 20 arrangement, setting out how an initial risk assessment can be completed. This assessment will enable the practitioner to take account of any immediate safeguarding and child protection issues. A full assessment, using the Framework, can be completed when young people are at home, and the information will feed into a targeted support plan for the young person and their family, where this is needed. If the risks of significant harm to the young person are deemed to be high, social workers must act on their duty to ensure that a child's welfare is appropriately safeguarded and promoted, which may include initiating care proceedings.

When children accommodated under Section 20 return home, they cease to be looked after. **Statutory guidance is clear that a child should continue to be supported and will often be treated as a child in need once they return home.** Some children may also return home under a child protection plan.

- **Children who are the subject of a care order or interim care order**

Where a child is the subject of a care order, a parent cannot remove them from a placement. A change in placement must be agreed as part of the care planning process. If a child returns home and continues to be the subject of a care order then this is a 'Placement with Parents'. Under these

⁵ See eg Wade *et al* (2011), Davies and Ward (2012).

⁶ Sinclair *et al* (2007).

circumstances the child retains their looked after status and the local authority must carry out their duties accordingly. The requirement for care planning, intervention and review remain and must be overseen by an Independent Reviewing Officer (IRO).

In some circumstances, a care order will be discharged as part of the reunification process. Where this is the case, the Framework will provide a structure for assessment, reaching a decision about reunification and what support might be required before, during and after the child returns home to family. The child will cease to be looked after at the point the placement ends and they return to the care of their family. Again, statutory guidance is clear that, where appropriate, a child should be treated as a **child in need for the purposes of ongoing assessment, intervention and support**. Again, some children may also return home under a child protection plan.

Practitioners, managers and strategic leads need to make sure that children and families receive the support they need regardless of the child's status before, at the point of or following reunification.

- The Framework supports local authorities to discharge their duties to **all looked after children** (those who are the subject of a full or interim care order and those who are accommodated under Section 20).
- The Framework primarily focuses on **reducing the risks of abuse and neglect** for children returning home from care. However the core approach, processes and understanding of research in relation to reunification which underpin the Framework (assessment, informed evidenced decision-making, planning, support and follow up) reflect good social work and are likely to be relevant when thinking about **all** children returning home.

- The Framework can be used at **any point where reunification is being considered**. For many children this will be **as soon as they enter care/accommodation**, but for some it may be after a period of time where there is a **change in their permanence plan** and reunification is deemed to be the best option. A child's care plan must include a 'plan for permanence' by the time of the child's second review. The care planning review will be used to consider the child's placement and the long term plan for the child. The review will also provide an opportunity to reflect on any change in the parents' circumstances including their capacity to provide safe care for their child over a sustained period.
- The Framework can be used when considering reunification for **children of all ages and characteristics**. Workers will adapt their practice depending on the circumstances of the case. Annexes are provided with further information to support work with babies, adolescents and parents with learning disabilities. When the case involves an older child, workers should be aware that the risks of abuse and neglect may come from outside the home and family environment.
- Where reunification is an option, parents need to be provided with services **as soon as possible** to help them address issues that may have led to their child becoming looked after. There should be **sufficient time** for preparatory work with the child and parents prior to return.

Further details about the definition of return home from care and the fit with court timescales is provided in Annex 11.

Why did we develop the Framework?

High rates of maltreatment and reunification breakdown

National Data

Returning home to a parent or relative is the **most common outcome** for children in care/accommodation. 34% of all children who ceased to be looked after in 2013–14 returned home.⁷ However, data from the Department for Education shows that of the 10,270 children who returned home from care in England in 2006–07, 30% had re-entered care in the five years to March 2012. So for almost a third of the children who had returned home, the arrangement had not lasted.⁸

Data from research studies

Research studies have shown **high rates of further maltreatment** following a child's return home, with **many returns breaking down** and children subsequently being taken back into care or becoming accommodated again. For example, almost half (47%) of the returns home in Farmer *et al's* study (2011) broke down within two years and a third of the children in this study experienced **two or more failed returns**.^{9,10}

Multiple failed returns are strongly associated with poor outcomes for children and also involve particularly high costs.¹¹ Reunification breakdown is not the only indicator of a poor quality return home. In the study just cited, **almost half (46%)** of the children were abused or neglected in the two years after they returned home and Sinclair *et al* (2005) had similar findings. Linked to this, in Wade *et al's* (2011) study, six months after the decision for reunification had been made, **this was judged to have been appropriate for less than half the children** (47%).¹²

Thoburn and colleagues (2012, p12) in their review of recent reunification research from the UK, US and Australia, concluded: 'There is a consistent finding that a high proportion of maltreated children who return home will return to care and others will remain at home but continue to be exposed to poor parenting, neglect and/or abuse'.

Re-entering care/accommodation following reunification will be in a child's best interests if s/he is not safe and well cared for at home. However, the underpinning rationale behind this Framework is that children **should only return home in the first instance where it is safe to do so**. Research highlights the need for robust assessments to decide whether or not reunification would be in a child's best interests and proactive case management and support services for those who do return.¹³ This Framework aims to help social workers and managers achieve this.

7 Department for Education (2014).

8 Department for Education (2013).

9 Studies with longer follow-up periods report higher rates of return breakdown and re-entry to care.

10 A study of a sample of new entrants to care (as opposed to those returned) showed lower rates of return breakdown– 15% of the 133 children discharged home returned to care within two years (Dickens *et al*, 2007). The studies cited above excluded children who returned within 6 weeks of entry to care and/or focused only on maltreated children.

11 See eg. Davies and Ward (2012), Holmes (2014).

12 Wade *et al* (2011).

13 Biehal (2006), Thoburn *et al* (2012), Davies and Ward (2012).

Why do so many reunifications break down?

Research indicates a range of factors which contribute to the high rate of reunification breakdown. These include:¹⁴

- lack of (or poor quality) **assessments** about whether or not the child should return home
- **passive case management**
- **a lack of appropriate services and support** for children and parents
- inadequate planning and **preparation** for return and **lack of monitoring** post return.

Wade *et al*'s research showed that **purposeful social work planning** which **included children and birth families**, and allowed children to go home **slowly**, over a longer period of time resulted in more successful returns home.¹⁵ Children and parents need **services and support** to overcome issues such as alcohol or drugs misuse and parental and child mental health difficulties.

However, one study found that, whilst almost half (46%) of the mothers and a fifth (17%) of the fathers to whom children returned were known to have alcohol or drug issues, only 5% received treatment to help them address their substance misuse.¹⁶

Information about **factors associated with failed and successful reunifications** is provided in Stage One (pages 24–28).

Follow this link <https://audioboom.com/boos/2600704-leanne-s-story> to hear Leanne's story about her experience of returning home from care.

There is a widely held misconception that reunification is more successful if it happens within the first six months of a child entering care or accommodation. This is inaccurate. Children are more likely to return to their families in this time period¹⁷, but research shows that when reunification happens without enough time to support parents to change, the child is more likely to re-experience abuse and neglect, and to come back into care or accommodation.

14 Biehal (2006), Davies and Ward (2012), Thoburn *et al* (2012).

15 Wade *et al* (2011), Thoburn *et al* (2012).

16 Farmer *et al* (2011).

17 See Biehal (2007) for a discussion of this issue.

How we developed the Practice Framework – learning from research and the experiences of local authorities

The NSPCC has been working with 14 local authorities and the Universities of Loughborough and Bristol since 2012 to develop, implement and evaluate the Practice Framework. The original Framework, known as *Taking Care* was delivered in partnership with nine local authorities and evaluated by the University of Loughborough.¹⁸ This re-worked Framework is based on a detailed literature review on reunification by the University of Bristol¹⁹ and the findings from the *Taking Care* evaluation.

The NSPCC has been supporting three local authorities to implement the Framework. The University of Bristol has evaluated this process, and the findings from the evaluation²⁰, alongside the views of parents, young people, local authority managers, practitioners and academics have informed this current version. The evaluations have shown that managers, workers and families viewed the Framework positively and were committed to implementing it.

What is included in the Framework? The approach and contents

The Framework promotes **professional judgment**, enabling workers to apply this judgement within a clearly **structured** approach. The aim of the Framework is to **improve outcomes for children** in relation to return home from care. This means making the best possible decisions about **whether or not** children return home. Therefore the decision for a child **not to return home following a thorough assessment and decision making process** will also be a good outcome for some children.

The core messages underpinning the Practice Framework are:

- **Robust assessments of risk and protective factors, of parental ability to care and their capacity to change** must be conducted to determine if children will be provided with safe, stable and nurturing care if they return home to their parents
- Social workers need to exercise **great caution when considering reunification with parents with the particular risk factors** that are most likely to lead to future harm, such as alcohol or drugs misuse and previous failed returns home
- The **child's best interests and voice** must be central to decision-making and planning
- **Parents should be given reasonable opportunity and support to change**
- **Support** from the following sources can be key to successful outcomes
 - Social workers and family support workers
 - Specialist services
 - Foster carers and residential carers
 - Schools
 - The family's informal network
- **Support, monitoring and review** should continue for **as long as it is needed**

18 Hyde-Dryden *et al* (2014).

19 This will be available at <http://www.bristol.ac.uk/sps/research/projects/completed/2016/returninghome/> and www.nspcc.org.uk/returninghome

20 This will be available at <http://www.bristol.ac.uk/sps/research/projects/completed/2016/returninghome/> and www.nspcc.org.uk/returninghome

What does the Practice Framework include?

The strength of the Framework is that it brings together the key messages from research about reunification, and translates them into tasks for workers to complete with children and their families. As such, workers are asked to consider research evidence, and then use this to inform their decisions and actions.

The evidence base underpinning the Practice Framework includes:

1. **Factors associated with future harm**
(Jones, Hindley and Ramchandani, 2006; White, Hindley and Jones, 2015)
2. **Key messages from the research on reunification**
3. **Key messages from the capacity to change literature**
4. **Risk Classification Framework (Traffic Light Tool)**

The evidence is discussed in detail in Stage One.

The essential practice for each case

- ✓ Assessment of risk and protective factors, and parental capacity to change
- ✓ Use of research evidence – see for example p25–28 of this Framework
- ✓ Analytical case history informing decision making
- ✓ Use of risk classification tool (traffic light) throughout the case
- ✓ Reflective case supervision
- ✓ Relationship-based work with children and families
- ✓ Child / young person has access to a trusted adult
- ✓ Written agreements and SMART goals created with parents to support and sustain changes
- ✓ Written multi-agency reunification plans for gradual returns, and with contingency plans
- ✓ Support and services for children and families pre and post reunification (including support from foster carers/ residential workers, schools and informal support)
- ✓ Assessments completed on children accommodated under Section 20 (including cases where the child/young person and/ or the parent end the S20 arrangement).
- ✓ Progress and outcomes are tracked and reviewed

The Annexes provide templates for reports and plans which local authorities can adapt and integrate with their existing care planning forms and templates.

Stage 1: Assessment of risk and protective factors and parental capacity to change

Aim: To engage the parents and the child in the assessment of the risk and protective factors if the child were to return home, and begin to assess the parent's capacity to change.

The following tasks will be completed:

- Task 1:** Produce an **analytical case history** and **genogram**
- Task 2: Engage children and parents** in the assessment process
- Task 3:** Conduct the **assessment** with parents and children
- Task 4:** Identify a **trusted adult for the child** to talk to
- Task 5: Write up the assessment.** Annex 5 provides a template with areas to cover in the report that can be used and adapted

Stage 2: Risk classification and decision on potential for reunification

Aim: To classify the risks associated with return home and make a decision about whether or not reunification will be possible at this time.

The following tasks will be completed:

- Task 1: Classify risk** using the **Risk Classification Table** (Traffic Light Tool) and **make decision** on the **potential for reunification**
- Task 2: Decision on the potential for reunification**
- Task 3: Communicate** the decision **to children, parents, foster carers/residential workers and all relevant professionals**
- Task 4:** Work with children and parents where **reunification is not possible**

Stage 3: Parental agreements, goal setting, support and continuing the assessment of parental capacity to change

Aim: To set clear goals with parents on what needs to be achieved before their children can return home, and to put in place services and support to assist them to meet these goals.

The social worker will complete the following tasks:

- Task 1: Communicate with children** about the aims and activities of this stage
- Task 2:** Draw up **written agreements** with parents (and children where appropriate) including **SMART goals** that need to be achieved (Specific, Measurable, Agreed with parents, Realistic, Timely) and the timescales in which to achieve them
- Task 3:** Provide direct **relationship-based social work support** to children and parents
- Task 4:** Create a **team around the child and family**, with **packages of services** for parents and children
- Task 5:** Create **contingency plans** and share them with the parents

Stage 4: Reclassification of risk, decision making and planning for reunification

Aim: To use the evidence gathered in Stage 3 to re-classify risk, make a decision about reunification and plan for return home where relevant.

The social worker will complete the following tasks:

- Task 1: Reclassify risk** and decide **on reunification** (with the team manager)
- Task 2:** Update the **parental agreements, goals and support plans**
- Task 3:** Agree a **multi-agency reunification plan**
- Task 4: Prepare** children and parents for return home

Stage 5: Return home

Aim: To support parents and children in the immediate reality of return home.

The social worker will complete the following tasks:

- Task 1:** Increase **contact** and **gradual return home**
- Task 2:** Coordinate **support and services** as detailed in the **reunification plan**
- Task 3: Monitor and review** post return
- Task 4: Re-classify risk**

Who can deliver the Practice Framework?

The Framework is designed to fit with and **complement the existing care planning and family support work** delivered by children's services and scrutinised by Independent Reviewing Officers. The process will be led by the child's social worker who will co-ordinate and feed back on progress and any changes to the reunification plan through the care planning review process. The child's **social worker** will be assisted by their **manager**, and where appropriate by **family support workers, Foster carers, supervising social workers, residential workers** and staff working with these children in **schools**, all have a significant role to play in supporting children and parents throughout the process.

Stages 1 and 2

We recommend that a **second worker** is used to produce the **analytical case history** and that this worker does not meet the family. This is based on strong messages from research and serious case reviews about bias in decision making and the value that an objective pair of eyes and an understanding of the case history can bring.²¹ The idea is that this worker can also join the child's social worker and manager in making the decisions about reunification. If it is not possible to allocate a second worker, we strongly suggest that an **additional worker reviews the evidence** collected and works with the social worker and team manager in deciding on the risk classification.

Stages 3, 4 and 5

The child's social worker will continue to coordinate the **team around the child and family** involving a range of professionals, and informal support from a variety of people and organisations. The key people supporting children and their families before and after return home need to read and take account of this Framework. Typically, family support workers may be brought in to work closely with the parents and children.

The following professionals may also be involved when a child they are responsible for is being supported under the Framework: the local authority legal team, the judiciary, children's guardians, foster carers' supervising social workers, schools, CAMHS, adult services, especially alcohol and drugs services, and those for mental health and domestic violence. It is important that where these professionals are involved in supporting reunification, they understand the rationale behind the approach in the Framework and the processes involved.

21 See for example Munro (1999), Turney *et al* (2011).

Principles underpinning the Practice Framework

These principles are the threads of good practice that run through all the work that the practitioner delivers with children and parents in relation to reunification.

Child at the centre

The core principle running through this Framework is that the child's best interests need to be at the centre of decision-making. Practitioners need to view the case from the child's perspective by listening to them, observing them and interpreting their behaviour.

Child-centred timescales

Having child-centred timescales means balancing the time needed for robust assessments and gradual returns home with children's timeframes and their need for stability and permanence. Thinking about return home needs to begin from the start of the child's looked after journey. Early engagement with parents is key.²²

Promoting the child's emotional wellbeing

The child's emotional wellbeing and mental health should be a key consideration throughout this process. This is not only because this is important to the child's wellbeing but also because the presence of emotional and behavioural difficulties are a risk factor for successful returns home.

Factors that influence children's emotional wellbeing include the stability and continuity of their relationships (relationships that are

important to the child should be supported as much as possible), and their sense of feeling listened to and understood by carers and professionals.

We recommend that robust screening tools, such as the SDQ, should be used early on to find out if children have severe emotional or behavioural difficulties so that these can be picked up and further support provided if needed.²³ Children with emotional and behavioural difficulties may need an assessment from a mental health professional in preparation for returning home, to identify whether they need additional support. If children are already receiving assistance from CAMHS or other emotional well-being services, this should continue for as long as it is needed after they return home, regardless of any change in their legal status.

Respectful engagement with families

The Framework responds to feedback from parents who said that they were not given enough support to tackle their problems, and that they didn't understand what changes they needed to make. A core principle of the Framework is that parents should be given reasonable opportunity and support to make the changes they need to, whilst ensuring the child's best interests are kept central to decision-making. The Framework therefore supports social workers to: work collaboratively with parents, help them to understand the changes they need to make, build on their strengths, show sensitivity, offer practical support, explain the consequences of breaching agreements and break 'bad news' where necessary.²⁴

22 Boddy *et al* (2013).

23 Bazalgette *et al* (2015).

24 Ward *et al* (2012), Child Welfare Information Gateway (2012).

Understanding diversity

The Framework should be adapted by the social worker to meet the needs of families from a range of backgrounds. Engaging, assessing and supporting families involves sensitivity to culture, religion, disability, sexuality and gender. Workers should be aware of any potential for bias in making decisions and delivering support to families with particular characteristics. Collaborative working, critical reflection, use of the research evidence and case supervision should be helpful in mitigating any such biases.

The importance of support for parents and children before and after return home

The Framework recognises the importance of relationship-based social and family support work, combined with support from foster carers/residential workers, schools, the family's informal network and specialist services.

The crucial role of the team manager (case supervisor)

The role of the team manager/case supervisor is absolutely crucial in ensuring that children and families receive evidence-informed practice that places the child at the centre and in ensuring that workers are able to give children and families the time needed to undertake the reunification work. The team manager needs to be familiar with this Practice Framework in order to support staff to work with it.

Readers should now have an understanding of: the rationale behind the Framework, the underpinning principles, the stages and the eligibility criteria. The following sections provide guidance on each of the five stages of the Framework.

The Return Home from Care Practice Framework

The following information is provided for each stage:

- Aim of the stage
- Tasks to be completed
- Messages from research
- Guidance and tools for completing the tasks
- Signposts to templates and further guidance in the annexes.

Stage 1: Assessment of risk and protective factors and parental capacity to change

"I don't know if I'm going home. I hope I am but nobody's told me"

12-year-old in *The Journey Home*, The Who Cares? Trust (2006, p7)

"It is a fantastic risk assessment tool"

Social worker in *Evaluation Report on Implementing the Reunification Practice Framework* (2015)

The aim of Stage 1

Stage 1 aims to engage the child, the parents, foster carers/residential workers and professionals in the assessment and decision making process. This work will fit in with the care planning processes. The purpose of the assessment is to gather and analyse information about the risk and protective factors to the child if they were to return home, and each parent's capacity to change. Stage 1 starts with the key messages from research which workers need to understand and apply to the assessment, and the subsequent work with children and families. By the end of this stage, workers will have completed a draft written assessment on the risk and protective factors, classification of risk, decision about return home and plans. A template with a set of questions is provided in Annex 5 for workers to use or integrate with local care planning templates.

At the start of Stage 1, the team manager will ideally identify an additional worker to compile a case history and work alongside the child's allocated social worker. If this is not possible, the allocated worker will complete the case history, but we strongly suggest that an additional worker is brought in to review the evidence and support the decision-making about return home.

Stage 1 Tasks

By the end of Stage 1, the case team will have completed the following tasks:

- ❑ **Task 1:** Produce an **analytical case history** and **genogram**
- ❑ **Task 2:** **Engage children and parents** in the assessment process
- ❑ **Task 3:** Conduct the **assessment** with parents and children
- ❑ **Task 4:** Identify a **trusted adult for the child** to talk to
- ❑ **Task 5:** Prepare a draft **Return Home Assessment Report**

Templates and guidance needed for Stage 1

Workers will use the following to complete the Tasks in Stage 1:

- Definition of Risk and Protective Factors (Annex 1)
- Risk Classification Table for families (Annex 2)

The following templates can also be used and adapted

- Template for gathering information for the chronology (Annex 3)
- Genogram template (Annex 4)
- Return Home Assessment Report template (Annex 5)
- Return Home Assessment Report for young people (Annex 6).

Key messages from research to guide and strengthen the assessment

The following pages set out **key messages from research** which underpin all the work with children and families before and after return, and where return home is not possible. Social workers need to understand these messages and apply them to their assessments, analyses, decision-making and planning.

a) Factors associated with Future Harm (Jones, Hindley and Ramchandani, 2006; White, Hindley and Jones, 2014)

Once abuse has occurred, there is a strong possibility of recurrence. The **factors associated with future harm**, shown below, are drawn from two systematic reviews of research studies of factors associated with recurrence of maltreatment.²⁵ (Annex 1 provides definitions of these risk and protective factors). **Social workers should collect data on the presence or absence of each of these risk or protective factors.**

All factors listed in the table below ('Factors Associated with Future Harm' p. 25) are associated with future risk of maltreatment and therefore need to be considered. Social workers will examine these factors **for each parent being assessed**, both separately and together. The factors with the strongest association with recurrence of maltreatment are in italics. The table should be used to assist and not replace professional judgement. There may, for example, be only one risk factor present but this could be so significant that the overall risk is severe. Or there may be a clustering of factors that cause particular concern.

25 The 2 systematic reviews together looked at 32 studies. The 2014 review of 15 studies covered 1.5 million cases. The authors applied a robust inclusion test which provides a very high standard of evidence.

Factors associated with future harm

NB Items in italics most strongly associated with maltreatment occurring

Factors	Future significant harm more likely	Future significant harm less likely
Abuse	Severe physical abuse including burns/scalds <i>Neglect</i> Severe growth failure Multiple types of maltreatment More than one affected child in the household <i>Previous maltreatment</i> Sexual abuse with penetration or repeated over a long duration Fabricated/induced illness Sadistic abuse	Less severe forms of abuse (defined in terms of harm, duration and frequency)
Child	<i>Developmental delay with special needs</i> Child's mental health problems <i>Very young child – requiring rapid parental change</i>	Healthy child Child does not blame him/herself for sexual abuse and recognises that it caused harm Later age of onset One good corrective relationship
Parent	<i>Personality disorder (anti-social, sadistic, aggressive)</i> <i>Paranoid psychosis</i> <i>Significant parental mental health problems</i> <i>Learning disabilities plus mental illness</i> Lack of compliance Denial of problems Alcohol/drugs abuse Abuse in childhood – not recognised as a problem History of violence or sexual assault	Mental disorder responsive to treatment Non-abusive partner Willingness to engage with services Recognition of problem Responsibility taken Adaptation to (coming to terms with) childhood abuse
Parenting and parent/child interaction	Disorganised attachment; severe insecure patterns of attachment Lack of empathy for child Poor parenting competence Own needs before child's <i>Parent-child relationship difficulties</i>	Secure attachment; less insecure attachment patterns Empathy for child Parenting competence in some areas
Family	<i>Inter-parental conflict and violence</i> <i>High stress</i> (associated with family stress, parental stress, large family size, poor home conditions and housing instability) Power problems: poor negotiation and expression of emotions; poor sense of autonomy Children not visible to the outside world and continuing perpetrator access	Absence of domestic abuse Non-abusive partner Supportive extended family Capacity for change
Professional	Lack of resources Poorly skilled professionals	Resources available: <ul style="list-style-type: none"> • Partnership with parents • Outreach to family • Therapeutic relationship with child
Social setting	Social isolation <i>Lack of social and family support networks</i> and lone parenthood Violent, unsupportive neighbourhood	Social support More local child care facilities Volunteer network Involvement of legal or medical services

(compiled from Hindley, Ramchandani and Jones, 2006; White, Hindley and Jones, 2015)

b) Messages from research on reunification

Workers and team managers need to read the messages from research VERY CAREFULLY.

The evaluation of the implementation of this Framework showed that practitioners and managers did not take all these findings on board.

They have important implications for successful reunification practice and therefore need to be taken into account when making decisions about children and families.

Workers need to be particularly alert to the following research findings from research on reunification:²⁶

- **Alcohol and/or drug problems are highly related to repeat maltreatment. In one study, 78% of alcohol or drug misusing parents abused or neglected their children after return home, as compared with only 29% of parents without these problems.**
- **Wade et al (2011) found that 81% of children reunified with alcohol or drug misusing parents experienced a return breakdown.**
- Children who experienced **previous failed returns home were more likely to experience a subsequent return breakdown**, and these children experienced the worst outcomes.
- Attempts to support parents sometimes continue for too long – in 38% of cases professionals in one study gave parents **‘too many chances’** to show they could care for their children.
- If Children’s Services are involved **during pregnancy and parents have not made substantial changes within 6 months of a baby’s birth**, real change is unlikely to occur.
- Looked after children who have experienced **chronic neglect or emotional abuse do significantly worse than others if returned home.**
- Return breakdown rates and the quality of returns vary greatly by **local authority** (especially for older children), showing that variations in practice make a major contribution to children’s outcomes.

Please see table ‘Messages from Reunification Research’ opposite on p.27.

26 Sinclair et al (2007), Brandon et al (2008), Thoburn (2009), Wade et al (2011), Farmer et al (2011), Davies and Ward (2012), Thoburn et al (2012), Farmer and Lutman (2012), Ward et al (2012).

Key Messages for Practice from Reunification Research

Factors associated with successful reunifications ²⁷	Factors associated with reunification breakdowns ²⁸
Children went to a changed household ²⁹	
	Children were over the age of 10
	Children have had previous failed returns home – additional help will be needed for these children and families.
	Children have behavioural or emotional problems – additional help will be needed for these children and families.
Thorough assessment , including a case history	Insufficient assessment & workers lacked knowledge of the child's history
Adequate preparation for return home had been provided for parents and children	Weak planning , particularly evident when returning home children accommodated under Section 20 – who were then left for too long in abusive circumstances without services to safeguard them. Children may then miss out on the chance of achieving permanence away from home, if that is needed.
Specialist services were provided for the parent/child	Service provision was inadequate – either services were insufficient, or provided too late, or were not intensive enough, or ended too soon to meet the severity of the parents' needs in order to make and sustain change.
	Parents' problems had not been addressed or remained unresolved or hidden, especially alcohol or drug problems which were highly related to repeat maltreatment – 78% of alcohol or drug misusing parents abused or neglected their children after return home, as compared with only 29% of parents without these problems.
Foster carers or residential workers supported and worked with the parents and children towards return home and were available to help afterwards	
Parents and older children had informal support from wider family, friends or people in their communities	
Children returned to parents only after sufficient time had elapsed for the problem that led to the original admission to have been addressed . So, returns home which happen gradually over longer periods of time have most success.	
There was consistent and purposeful social work and monitoring with the child and parent/s	
Conditions were set for parents before return home	
There was clear evidence of parental change	Parents were ambivalent about the return and/or isolated

27 Biehal (2006), Thoburn (2009), Wade *et al* (2011), Farmer *et al* (2011), Child Welfare Information Gateway (2011), Davies and Ward (2012), Thoburn *et al* (2012).

28 *Ibid*.

29 i.e. removed from one parent and returned to the other separated parent or went to the same family where the parent had a new partner or a former partner had left.

c) Messages from the 'capacity to change' literature

There is increasing understanding within social work about the importance of assessing **parental capacity to change**, in addition to exploring parents' **ability** to meet their children's needs.

Positive indicators of capacity to change include:³⁰

- the ability to **end a violent relationship/relationship** with person who posed a risk to the child
- sufficient insight to **acknowledge the damaging effect** of their **own previous behaviour**
- ability to **overcome difficulties** and
- having **come to terms with the removal of an older child** (if applicable).

Parents should be given **opportunities and support to change**. This needs to be balanced with the **best interests of the child**.

Ward *et al*'s³¹ recent overview of the evidence in relation to assessing parental capacity to change identified some circumstances in which sufficient change is **highly unlikely**, and the child/ren will need to be separated from their parents.

These are:

- Cases of **extreme domestic violence** where the perpetrator shows a pervasive pattern of disregard for and violation of the rights of others.³²
- Cases of **substance misuse when combined with domestic violence**.³³
- Cases where **children are not protected from sexual abuse perpetrators or parents systematically cover up deliberate abuse**.³⁴

Dr David P H Jones advises:

*"We have to acknowledge that some situations cannot be changed for the better, and that some families are simply untreatable. These situations are major challenges for children's social care and other services, but must be faced and responded to by front-line workers and their supervisors. These cases do not represent failure, but in fact successful professional practice, to the extent that a sustained focus on child welfare has been achieved."*³⁵

d) Learning from serious case reviews

The NSPCC have collated learning from serious case reviews on issues including:

- substance misuse
- parental mental health
- domestic abuse
- hidden men
- teenagers

They can be accessed here: <http://www.nspcc.org.uk/preventing-abuse/child-protection-system/case-reviews/learning>

30 Ward *et al* (2012).

31 Ward *et al* (2014, p. 82).

32 Gondolf (2002), Scott (2004) (cited in Ward *et al* 2014).

33 Forrester and Harwin (2008) (cited in Ward *et al* 2014).

34 Brandon *et al* (2008) (cited in Ward *et al* 2014).

35 Jones (2009, p302) (cited in Ward *et al* 2014).

Task 1: Produce an analytical case history and genogram

Workers should now have a sound understanding of the key messages from research about reunification which need to shape their analysis of the case history. The case history will build on a significant events chronology, but the focus will be on identifying and analysing **patterns** of risk and protective factors and **evidence** of parental capacity to change.

The worker can use the chronology table template (Annex 3) to organise information gathered, before writing up their analysis in a report. Annex 5 provides a template that can be used/adapted.

Writing the case history involves systematically gathering and analysing data from sources such as local authority case files/records and health or education services on the following inter-related areas:

- Assessments already completed
 - Parents' history, including their own experiences of abuse and neglect (if available)
 - Abuse, neglect and other adversities experienced by the child and siblings. This needs to include an understanding of abuse experienced by the children outside the home.
 - Risk factors and also protective factors that mitigate those risks (refer to messages from research above)
- Existing evidence of parental capacity for change in order to parent their child/ren effectively
 - Support and services that have been tried/ completed in the past and their success or failure and how well the parent/s engaged with services
 - Previous failed returns home and what went wrong
 - Attachment of child to parents, foster carers/residential workers, step-parents, siblings and other relatives
 - Any special needs of each child.

The case history should be presented as a critical analysis of these themes in the family's history, and not a list of events. The worker will seek to bring out the underlying reasons for the parents' difficulties.

The evidence needs to be probed to establish its accuracy and meaning. Action should be taken to address any gaps in the information. This may involve interviewing those with direct knowledge of the child and family.

If an additional worker is completing the case history, it is recommended that they have limited contact with the child or family in order to eliminate any bias. Workers will share their findings and update each other when new information is found.

The case history should be updated throughout the case.

Please see Annex 3 for tips on producing an analytical case history and a case study showing how an understanding of the case history benefits the child.

Task 2: Engaging children, parents, caregivers and relevant professionals in the assessment process

Workers need to engage parents and children so that they can actively and genuinely participate in the process. In doing so, they should consider the following:

- Parents will already have experienced separation from the child (often accompanied by feelings of failure and low confidence about their ability to care). Therefore workers need to be sensitive to parents' and children's feelings about working with children's services. It is important to work through parents' anger (and other feelings) about their children becoming looked after.
- Parents in various studies reported that they didn't understand what they needed to change. Children said that they were not consulted and they didn't understand why decisions were made to return/not to return them home, whilst some children may not understand why they became looked after in the first place.
- Parents value workers who are straightforward about what needs to change and the consequences of failing to do so, who show sensitivity and listen and who offer practical support, and help to build up their confidence as parents.

Engaging with diverse families

Workers need to be mindful that children with certain characteristics are particularly vulnerable to abuse and neglect. For example, disabled children are three times more likely to experience abuse and neglect than others. Workers should be aware that mixed, black and 'other' minority ethnic children are over-represented amongst looked after children, whereas Asian children are under-represented.³⁶ Whilst the reasons for these trends are not clear, an awareness of the interplay between a child's background and circumstances, and the system's response to these circumstances, should support workers and their managers to challenge any potential biases in their judgement. Reflective supervision will be used to consider the child and the parents' identities and the potential impact of these identities on the child's vulnerability, relationships between the family and services, and decision-making.

Using the Risk Classification Table (Traffic Light Tool) to engage parents and children

The Practice Framework uses a Risk Classification Table, developed by the University of Loughborough – see Stage 2 below. The table is presented in traffic light colours to help parents and children to understand the risk and protective factors, what needs to change and the outcomes of decisions.

³⁶ Owen and Statham (2009).

Social workers will show parents and children the Traffic Light Tool to explain the purpose and rationale behind the assessment.

Annex 6 provides a simplified version of the table for workers to use with children and families.

When engaging parents and children in the assessment, social workers need to:

- Ensure that parents (and children) understand the professional concerns that led to entry to care/accommodation.
- Ensure that parents and children understand the aims of the assessment and how decisions will be made.
- Treat all families equally, regardless of their background. Workers should be sensitive to parents and children who do not have English as a first language, those who find it hard to communicate or who may need extra help to understand, such as parents with learning difficulties.
- Check that all parents and children understand what is being said and written by asking them to put it into their own words.
- Where appropriate, put in place support and services for parents and children during the assessment stage. How parents interact with this support will form part of the assessment, and support plans will be adapted in Stages 3, 4 and 5.
- Involve foster carers or residential workers and other relevant professionals in the assessment.

A solution-focused approach for supporting children and young people.

Practitioners can use a solution-focused approach when working with children and young people. Solution-focused techniques support practitioners to help children / young people move towards the future they want and to make positive changes in their lives.

See Annex 12 for details of worksheets and activities that can be used with children and young people aged 5–18 to elicit their views and to support conversations about the future, what needs to change, the journey and the child's strengths and support network.³⁷

The following annexes provide additional support for engaging with families

- Annex 12: Tips for working with children and young people
- Annex 13: Considerations when assessing return home from care in relation to babies
- Annex 14: Assessing risks and protective factors and planning for positive outcomes for adolescents in relation to return home from care
- Annex 16: Engaging parents
- Annex 17: Working with parents with learning difficulties

37 <http://www.nspcc.org.uk/globalassets/documents/publications/solution-focused-practice-toolkit.pdf>

Task 3: Conduct the assessment of risk and protective factors and parental capacity to change

This section focuses on assessing a parent's capacity to change. However, it is important to note that sometimes the assessment will focus simply on the parent's capacity to care adequately for the child, for example where the child went into care/accommodation from one parent (say the mother) and the plan is for return to the other parent (the father), about whom there are no known problems. A somewhat similar situation occurs when the main difficulties are a child's profound difficulties, where the assessment will focus on whether the parent/s will be able to care if sufficient support is provided to the child and to them. Where problems centre principally on a young person's behaviour, the assessment will cover how far the young person has been able to change and how far the parent/s will be able to care for him/her with support.

Workers should refer to the Return Home Assessment Report (Annex 5) for a list of the questions they need to answer during the assessment.

Social workers will complete the assessment by:

- Talking to children alone / observing non-verbal children
- Observing parent / child interaction
- Talking to parents, together and separately, including new parental figures
- Using tools and techniques
- Cross-referencing with the case history
- Talking to other professionals, foster carers, residential workers, schools

Assessing children

The children's social worker needs to gather and analyse information on the following issues.

Children's views of:

- Their parents' **capacity to change**.
- Their **wishes, feelings and motivations** in relation to returning home or remaining looked after. The worker should consider how the child/ren understand the relative risks and benefits of staying in care/returning home.
- Any **new partner** that their parent now has and the child's relationship with that partner.
- The **services and support** that they think they will need if they return home.

The child's specific strengths and needs, with attention to:

- The presence or absence of the **risk and protective factors** in the **Factors Associated with Future Harm Table** (see page 25)
- **Age at which child became looked after.** The earlier the separation from the parent took place, the greater the challenges of returning a child home.
- Children who have **moved a lot in care** are likely to present greater difficulties when returned home.
- **Child's attachments** to each of the birth parent/s, and to their foster carers.
- **Babies:** Behavioural observations including the quality of relationship between baby and parent is vital
- **Contact** between birth parent/s and child whilst looked after.
- The nature and severity of the **child's emotional and/or behavioural difficulties.** Workers may consider using a standardised measure such as the SDQ which can gather foster carers'/residential

workers' (and if wished teachers' views) of the child, and help to establish what needs the child may have.

- Children who have been **carers** for their parents, before becoming looked after. The worker should understand the impact on the child of returning to this dynamic with their parent/s.
- In some situations, return home has to be tried (if it is safe to do so) to help the child understand that his/her parents may not be capable of caring for him/her, so that s/he can 'cut their losses' and settle with another family.³⁸
- **Relationships with siblings** in care and/or at home.
- Any problems related to **school**.
- **Any cultural issues** that may have a negative impact on the child's well-being if returned home, for example, instances where parents may misuse culture as a way to harm the child.
- **Positives and strengths in the child's life.**

Assessing parents and their capacity to change

The reunification assessment generally involves parents who have previously abused or neglected their children, or failed to protect their children from abuse or neglect. As such, the social worker needs to answer the following questions in the assessment report:

- Have the problems that initially resulted in the child coming into care/accommodation been addressed?
- Are the parents ready and able to address any remaining or new risk factors (including the impact of separation on their relationship with the child)?
- Are the parents likely to be able to make the necessary changes within the child's timescales, taking account of the child's

age and developmental needs? Are they able to make use of the support and services provided? Workers should be particularly mindful of timescales for very young children.

- Can the relationship between the child and the parent be sufficiently repaired after the experience of abuse and neglect followed by separation?

Workers should obtain sufficient information to enable them to determine **whether there is no evidence, some evidence or substantial evidence of parental capacity to change in time to meet the child's needs**. Workers will assess capacity to change by working with parents to set the goals to be achieved, access support for them and review whether or not parents meet these agreed goals within the set timescales.

Use of standardised measures as part of assessing parental capacity to change

Alongside the assessment it is suggested that social workers consider the use of a range of standardised measures/assessment approaches to establish a baseline on a particular aspect of family functioning that has been identified as a concern. Standardised measures can provide an objective measurement of change, complementing the worker's analysis.

Workers will then re-administer the measures in Stage 4 after goals have been set and following a period of support and intervention in Stage 3. In Stage 4, workers will use this information to guide the reclassification of risk and decision-making in relation to return home.

Please see Annex 19 for further guidance about assessing parental capacity to change including more information about standardised measures.

38 Fein *et al* (1983), Thoburn *et al* (2012).

The worker needs to explore the following issues in the parental assessment:³⁹

- The presence or absence of the **risk and protective factors** in the **Factors Associated with Future Harm Table** (see page 25).
- Any significant **gaps or contradictions** in the chronology.
- The **child's full history** including patterns of past and current **attachments** and other close relationships (with parent/s step-parents, parent's partner, current foster carers/residential staff, relatives, siblings).
- The **psycho-social history of the parents**, including their own experience of abuse (if any) and its impact on current parenting practices; their attitudes to child rearing, their intellectual functioning and ability to regulate their emotional state.
- The key **parental difficulties** which need to improve before children can be returned home. Workers should ask parents to describe their problems and should always ask about their **current and past alcohol and/or drugs use**, experiences of **domestic abuse** and **mental health**.
- Parents' views of **help** provided in the past – what worked and did not and why? Explore parent's views of **why the children came into care/accommodation**, information on any **failed returns home** and why they broke down.
- Parents' **motivation to change** and get the child home, with attention to the risk of 'false compliance' or a determination 'to prove the social workers or courts got it wrong'.
- **Stressful life events** for the family, external demands on the family and the availability of **support**.
- Parents' ability to care both **together or separately**, and the ability of the parents to separate. It is important to take a view on who was the abuser or person responsible for the maltreatment and to distinguish between the capabilities of the abusing parent and the potentially protective parent.
- **'Hidden' men** Serious case reviews and domestic homicide reviews have highlighted the risks posed by 'hidden men'. These are the partners or acquaintances of mothers who remain hidden or elusive during assessment work, and who pose serious risks to children. Any assessment of the risks associated with return home needs to explore the relationships and close social networks of parents.
- **Risks from outside the home:** The worker needs to assess the parents' ability to manage the risks faced by their children outside the home. See Annex 14 for information on adolescent risk
- **Parents with learning disabilities – see Annex 17**

39 Festinger (1996), Dawe and Harnett (2007), Brandon *et al* (2008), Thoburn (2009a), Honomichl *et al* (2009), Turney *et al* (2011), Thoburn *et al* (2012), Barker *et al* (2014), Ward *et al* (2014).

Task 4: Identifying a trusted adult for the child

It is important that *throughout* the assessment and return home process, children have a trusted adult who they can talk to and who can support them to express their views and concerns about reunification. One study found that a third of the children had confided in no one once they had returned home. This role can be played by the social worker, who should make every effort to build a relationship with the child. However, some children may be reluctant to raise concerns with their social worker, for fear that it may trigger a change in plan. The social worker needs to ensure that at least one trusted adult has been identified by and for the child. This could be a foster carer, residential worker, relative, teacher or mentor and it should be someone who can continue supporting the child if they return home.

If a child does not have anyone currently in their life to fulfil this role, they could be offered an independent worker or advocate, who should be able to remain involved throughout the process. Introducing this person at the start will allow time for the relationship to develop.

Task 5: Preparing the Return Home Assessment Report (as part of care planning)

Consideration of reunification is part of care planning for looked after children. The report template in Annex 5 suggests the questions that workers need to address to inform their planning. These questions can be added into existing assessment and care planning documents used by the local authority. Annex 6 provides a version to be shared with children and young people. By the end of Stage 1, worker/s will have drafted the majority of their report. At the risk classification meeting, which starts off Stage 2, they will present to their manager their analyses of the level of risk associated with the child returning home. The IRO should also be involved.

Stage 2: Risk classification and decision on the potential for return home

The aim of Stage 2

The aim of Stage 2 is to classify the risk associated with return home and make a decision about whether or not reunification will be possible at this time. The guidance below will support workers to make these decisions, communicate with children and families and take the next steps where reunification is not possible.

It is important to acknowledge that in the real world it is not always as simple as making a decision about returning a child home and this decision may not be in the practitioner's gift. This is because sometimes the parent or child will pre-empt what the practitioner is planning, for example when the parent removes a child who is **accommodated under Section 20** from his/her placement or when an accommodated young person goes home of their own accord. In this situation, the practitioner needs to undertake an assessment of whether living at home is safe and suitable after the young person is already there (see stage 1) and provide services as needed (see regulations and guidance [summarised in Annex 10, p.99] which make it clear that these young people will be children in need).

In addition, some parents are so worn down by being the recipient of challenging behaviour that they are relieved when a young person becomes looked after and may not wish them to return home. The decision on whether the young person returns home will then turn on whether the young person's behaviour changes, how well the parents can manage his/her behaviour and whether the relationship with their parents can be repaired.

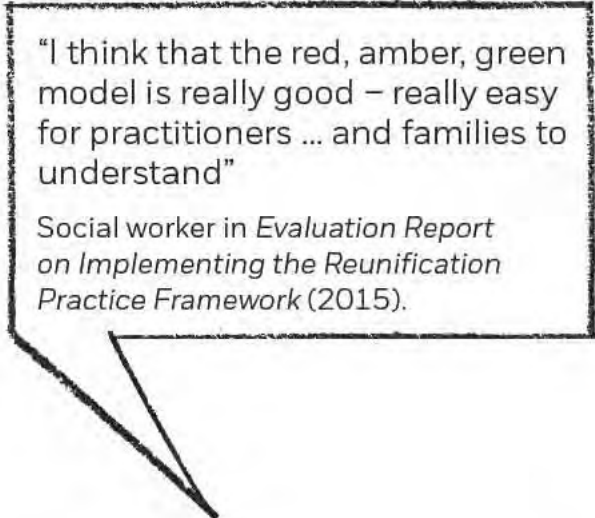

"I think that the red, amber, green model is really good – really easy for practitioners ... and families to understand"

Social worker in *Evaluation Report on Implementing the Reunification Practice Framework* (2015).

Stage 2 Tasks

By the end of Stage 2, the following tasks will have been completed:

- Task 1: Classify risk and make decision** using the **Risk Classification Table** (Traffic Light Tool)
- Task 2: Decision on the potential for reunification**
- Task 3: Communicate** the decision **to children, parents, caregivers and all relevant professionals**
- Task 4:** Work with children and parents where **reunification is not possible**

Task 1: Classification of Risk

The risk classification framework was developed by researchers in response to findings from three major studies which were all part of the *Safeguarding Children Research Initiative* (see Davies and Ward, 2012). In the Davies and Ward research overview (2012), these were referred to as the *Neglected Children Reunification Study* (Farmer and Lutman, 2012); the *Home or Care? Study* (Wade *et al* 2010); and the *Significant Harm of Infants Study* (Ward, Brown and Westlake, 2012; Ward, Brown and Maskell-Graham, 2012a). It has been adapted by the NSPCC and Loughborough University to be relevant to all ages of abused and/or neglected looked after children who are being considered for reunification.

At the end of the first assessment cycle, the risk of future significant harm to the child, if returned home, is classified as **severe, high, medium or low**. The classification of risk will guide the decision about return home. The worker, the team manager, and either the worker who wrote the case history, or someone who has independently reviewed the case, will independently classify risk, and then confer and make a collaborative decision about the potential for reunification.

The case team should work closely with the IRO, and can present their recommendation to the child's Looked After Review. If a review is not possible within an appropriate timescale, the IRO should still be involved in the decision making and planning.

When making decisions, workers must take into account the research and refer to The Factors Associated with Future Harm, and Messages from Reunification Research found on pages 25 to 28.

For example, in cases where parental substance misuse is an issue, workers should be mindful that in one study 78% of alcohol or drugs misusing parents abused or neglected their children after return home, compared with maltreatment by only 29% of parents without these problems.

The Risk Classification Table is intended to guide and structure decision-making, taking into account the age, abilities and unique characteristics of each child and their relationships. It should not be used in an overly prescriptive way. The Table indicates which decision about reunification is *most likely* to be appropriate based on the level of risk identified.

The Risk Classification for Reunification table should also be used throughout:

- As a basis for drawing up agreements with parents
- As the basis for planning services and interventions
- To communicate with parents and children and explain decisions and plans to them
- To monitor and review progress after the child has been returned home.

The intention is to support families who can to move down the risk classification table, until they can sustain low risk. Alternatively, if families present high or severe risks and are unable to change, this tool assists practitioners to make a decision not to return the child home but instead seek a permanent placement away from the birth family.

Full detail is provided in the table on page 40 and can be summarised as follows.

Severe risk

- **Risk of abuse or neglect is too high to permit a return home**
- Risk factors apparent (and not adequately addressed)
- No significant protective factors apparent
- No/not enough evidence of parental capacity to change
- Ambivalence or opposition to return home by child and/or parent.

High risk

- Strong possibility that abuse and/or neglect will occur if child returns home
- Risk factors apparent (and not being adequately addressed)
- At least one protective factor apparent which mitigates risk
- No/not enough evidence of parental capacity to change
- Ambivalence or opposition to return home by child or parent
- **Significant evidence of change needed before a return home can be considered.**

Medium risk

- Some possibility that abuse and/or neglect may occur
- Risk factors apparent (or not all risk factors adequately addressed)
- At least one protective factor apparent (which mitigates risk)
- Evidence of parental capacity to change
- Parents and child both want return home to take place
- **Return home should be considered**, but with plans in place to reduce risk factors and sustain change.

Low risk

- Unlikely that abuse or neglect will re-occur
- Previous risk factors fully addressed. Any other risks are at a low level which can be safely managed.
- Protective factors apparent
- Evidence of parental capacity to sustain change
- Parents and child both want return home to take place
- **Return home should be actively considered.**

Strengths vs protective factors

Workers need to scrutinise the **quality** of the protective factors. They also need to identify those protective factors which **mitigate the risks** to the child. These factors need to be distinguished from positives or strengths which may not be sufficient to alleviate the specific risks to the child. For example, parents may attend a parenting course and may try to implement their learning, which would be positive and show motivation to change. However, if this is not actually effective in addressing the identified problems in their parenting, it cannot be described as protecting the child from risk.

Risk of abuse from outside the home

There is a growing understanding of the risks faced by older children from outside the home, for example from sexual exploitation and gangs. These risks may have been the reason why the child was brought into care/accommodation, or they may emerge whilst the child is looked after. The worker should consider the changes needed in the child's life and environment in order for them to be safe either at home or in care/accommodation. Annex 14 contains more information on risks faced by adolescents.

Risk Classification Table

Low risk	Medium risk	High risk	Severe risk
Previous risk factors fully addressed. Any other risks are at a low level which can be safely managed.	Risk factors apparent (or not all risk factors fully addressed)	Risk factors apparent (and risk factors not being addressed)	Risk factors apparent (and risk factors not being addressed)
Protective factors apparent	Protective factors apparent	Protective factors apparent	No protective factors apparent
Parents ABLE to demonstrate sustained capacity for actual change	Parents ABLE to demonstrate sustained capacity for actual change	Parents UNABLE to demonstrate sustained capacity for actual change	Parents UNABLE to demonstrate sustained capacity for actual change
Parents and child both want return home	Parents and child both want return home	Ambivalence by parent and/or child re return home	Ambivalence by parent and/or child re return home
Unlikely that abuse will recur if child returned home	Some possibility that abuse will recur if child returned home	Strong possibility that abuse will recur if child returned home	Very strong possibility that abuse will recur if child returned home
Return child home following preparation with reunification plan, parental agreements, support for child and parents and monitoring. (Child In Need Plan/Placed with Parents)	Return child home following preparation with reunification plan, parental agreement, support for child and parents, services to reduce risks and increase protective factors and regular monitoring. (Child in Need Plan/Child Protection Plan/Placed with Parents)	Further interventions and evidence of parental ability to engage and change required before child returned home. Retain Care Order. Begin concurrent planning for possibility of permanent separation	Child remains Looked After. Legal proceedings instigated if required. Plan for permanent separation within timescale appropriate to child's development, needs and wishes
If parents can maintain 'low risks' for a period of at least six* months the case can close.	If parents address all risk factors and maintain the change for at least six months the case can move to 'low risk', where it should remain for a further six months before closing.	If parents develop a capacity for actual change and begin to address risk factors, and protective factors remain apparent this should be sustained for at least six* months before the case can move to 'medium risk' where it should remain for a further six* months before moving to 'low risk'.	If protective factors become apparent and/or parents begin to address risk factors, within timescale appropriate to child's needs, this should be sustained for at least six months before moving to 'high risk'.
If new risk factors emerge/ previous risk factor re-emerge and parents are able to show demonstrable capacity for change and protective factors are apparent the case will move to 'medium risk' for further interventions and monitoring.	If parents are unable to address all risk factors but are making use of interventions to address them and protective factors are apparent the case should remain 'medium risk'. As long as no new risk factors emerge or previous risk factors re-emerge that had previously been addressed.	If parents remain 'high risk' for six months without addressing risk factors the case should move to severe risk with plan for permanent separation.	
If new risk factors emerge/ previous risk factors re-emerge and parents are unable to show demonstrable capacity for change yet protective factors are apparent the case will move to 'high risk', for further interventions and monitoring.	If new risk factors emerge/ previous risk factors re-emerge and parents are unable to show demonstrable capacity for change yet protective factors are apparent the case will move to 'high risk' for further monitoring.	If protective factors are no longer apparent the case should move to severe risk with plan for permanent separation.	
If new risk factors emerge/ previous risk factor re-emerge and parents are unable to show demonstrable capacity for change and no protective factors are apparent the case will move to 'severe risk' and child will return to care with legal proceedings instigated if necessary.	If new risk factors emerge/ previous risk factor re-emerge and parents are unable to show demonstrable capacity for change and no protective factors are apparent the case will move to 'severe risk' and child will return to care, with legal proceedings instigated if necessary.		

Developed by Rebecca Brown, Loughborough University.
Adapted by NSPCC for reunification of looked after children.

Timescales for return home

There are strong messages from research that returns home are more successful when they are **gradual**, and when there is sufficient evidence of the **parent's ability to sustain changes**. **Six months** is the suggested minimum amount of time needed for parents to evidence that they can *sustain* the changes they have made.⁴⁰

Please note:

There is a widely held misconception that returns home are most successful if they happen within the first six months of a child becoming looked after. This is not true. Returns home may be more likely in this time period, but research shows that when reunifications happen without enough time to support parents to change, the children are more likely to re-experience abuse and neglect, and to come back into care.

The Risk Classification Table suggests the following timescales in relation to return home:

Low risk

When the risk is classified as **low** a return home should be actively considered. The social worker and the parents will create written parental agreements, detailing goals that need to be achieved and services that will be provided (Stage 3). For some low risk cases, the parental agreements can feed directly into the reunification planning stages (Stages 4 and 5). Continued monitoring will be needed but provided changes are maintained and no new or pre-existing risks emerge it may be possible to close the case, or step down the support, once evidence of a successful reunification has been demonstrated – a minimum of **six months** after the child has returned home.

It should be acknowledged that episodic services may be needed at times of stress and parents and children should be aware of how to access such services. If risks emerge, the case may require re-classification as medium, high or severe depending on the nature of the risks, the presence of protective factors and the evidence of capacity for change.

Medium risk

When the risk is **medium** there is some possibility that abuse or neglect will take place but reunification should be considered, with written parental agreements, goals, and a package of preparation, support services and monitoring (Stage 3). If all remaining risk factors are addressed and change is sustained for **6 months** the case can be reclassified as **low risk** (Stage 4). If new or pre-existing risks emerge the case may require re-classification as either high or severe depending on the nature of the risks, the presence of protective factors and the evidence of capacity for change.

High risk

Where the risk is **high** there is a strong possibility that abuse or neglect will occur if the child returns home. Further support and evidence of change are therefore needed before a return home can be considered if the child's timescale allows (Stage 3). The risks will be re-classified in Stage 4. If there is sustained positive change for **6 months**, the risk level should be re-classified and reduced to **medium**, at which point a return home could be planned. However if the case **remains at high risk for six months**, this should lead to a re-classification of **severe risk** and plans for permanent alternative placement should be made in the child's best interests. These timescales may need to be adjusted either way depending on the age of the child, but 'drift' should be avoided.

⁴⁰ A timescale is included because of the risks associated with cases drifting (about which there is a great deal of research evidence). We use 6 months as the minimum time needed to evidence sustained change to reflect Wade *et al's* (2011) finding that even in cases where the reunification did not break down for several years, the problems were apparent at 6 months (see also Ward *et al* 2014).

It should be noted that ‘no change’ within a specified time period should be considered a risk factor.

Severe risk

Where the risk is **severe** the possibility of abuse or neglect is too high to permit a return home and the child should remain in care. Where children are accommodated under Section 20, consideration should be given to instigating proceedings. Plans should be made for permanent placement and work undertaken with the child and parents to deal with this most difficult of decisions. Consideration needs to be given to the nature of continuing links and the role that parents and other family members can continue to play in the child’s life.

Task 2: Decision on the potential for reunification

The risk classification will guide the decision about whether or not there is a realistic prospect of changes taking place on a timescale that is appropriate to the needs of the child. This decision must take into account the individual child’s circumstances, strengths, vulnerabilities and developmental needs and the likely availability and acceptability to the parents/older children of any services that may be necessary to ensure that care is improved and sustained.

The decision about whether or not return home will be possible can be made at the Looked After Children’s review, where the case team – the chronologist, the children’s social worker and the team manager or supervisor – can make a recommendation. If a review is not possible within an appropriate timescale, the case team can make the decision themselves, but they should involve the IRO and any other key people.

Task 3: Communicate the decision to children and parents

The Risk Classification Table can be used to communicate with parents and children and help them to understand the outcome of the assessments and the reasons for the decisions made.

It is critical that the assessment is not a stand-alone activity. For those children for whom return home is being considered, the assessment will remain live and inform the agreements and support plans going forward.

Stage 3 below describes the work with parents and children following a decision that a reunification may be possible.

Task 4: Work with children and parents where reunification will not be possible

When the assessment decision is that the child/children will *not* be returning home, the report should be clear about permanence plans and contact arrangements. Workers should support children and families to maintain their relationships where this is safe and appropriate for the children. Information about how decisions have been made, and what will happen next, needs to be communicated in a way which facilitates understanding for parents and children. This is an important part of the assessment. The way in which this is approached can have a significant impact on how children and parents are able to accept the decisions and move forwards.

If the decision not to reunify represents a change to the Court Care Plan or, for children accommodated under Section 20, if the plan is to proceed to an application for a care order, the parents should be advised to contact a solicitor and this work will become part of the pre-proceedings process. It may be appropriate at this stage to talk to parents and children about kinship carers and the possibility of holding a Family Group Conference.

A decision not to reunify a child with their parents at this stage may lead to the child finding alternative permanence with another family. Some workers find it difficult to see a decision not to return a child home as a success. However, when a decision not to return a child home is in the child's best interests this is a successful outcome as it allows a permanent alternative placement to be found for them and so secures their future. Workers need to ensure that children have meaningful contact with their birth families, including siblings where this is in the child's best interests.

See Annex 21 for additional guidance for working with families where reunification will not be possible.

See Annex 22 for information about families who experience multiple removals of their children.

Annex 23 gives an example of a later life letter which can be written to explain to children about why and how decisions were made about their lives.

Life story work is important as it can help a child to understand their past and how this links to their present. It may not be appropriate to do this direct work with the child immediately after a potentially upsetting decision but workers should bear in mind that the child should be offered life story work when they are ready.

Where alternative carers are identified they will need to have a good understanding of decision-making and past life events so that they can help reinforce messages to the child.⁴¹

By the end of Stage 2, parents, children (where appropriate), foster carers/residential workers and other professionals should understand the result of the assessment and whether or not there is potential for reunification. Stage 3 focuses on the goals and support needed for reunification to be achieved.

⁴¹ See case example in Bazalgette *et al* (2015). p. 81.

Stage 3: Parental agreements, goal setting, services and support and continuing the assessment of parental capacity to change

The aim of Stage 3

In Stage 3, the focus shifts to those families where reunification is a possibility. The aims of Stage 3 are to set clear goals for parents on what needs to be achieved before their children can return home, and to put in place services and support to assist them to meet these goals. At this stage, workers may partner with family support workers, and foster carers or residential staff should be actively involved in supporting children and families.

This pre-reunification stage will lay solid foundations for those children who do end up returning home. Much of the support and services offered at this stage will continue once children return home.

By the end of Stage 3 parents will have had the opportunity to demonstrate their capacity and willingness to change. Social workers will gather and analyse information throughout Stage 3 to inform the reclassification of risk in Stage 4. The information gathered in Stage 3 will feed into care planning – it will be shared with the IRO and presented to the Looked After Children Review as the decision-making forum.

“All the questions that I asked was answered as truthfully as possible, not sugar coated. She said it would be hard ... Always kept in the loop, kept informed by regular visits, phone calls, reports”
Parent, *Taking Care: Practice Framework for Reunification Evaluation Report*, Hyde-Dryden et al (2015, p40)

“I would have liked more contact to get to know (my mother) better, to get used to it and to be asked about how I felt about going home”
17-year-old in *The Journey Home*
The Who Cares? Trust (2006, p8)

Stage 3 Tasks

By the end of Stage 3, the social worker will have completed the following tasks:

- Task 1: Communicate with children** about the aims and activities of this stage
- Task 2:** Draw up **written agreements** with parents (and children where appropriate) including **SMART goals** that need to be achieved (Specific, Measurable, Agreed with parents, Realistic, Timely) and the timescales for achieving them
- Task 3:** Provide direct **relationship-based social work support** to children and parents
- Task 4:** Create a **team around the child and family**, with **packages of services** for parents and children
- Task 5:** Create **contingency plans** and share them with the parents

Task 1: Communicate with children

Research suggests that the views of the child are often overlooked. The social worker should **see the child alone**, and use the simplified Risk Classification Table (Annex 6) to explain this next stage and elicit their views on:

- Their hopes and fears about returning home, and the best timing for them
- The support they need to prepare for a return home
- What changes they think their parents need to make for it to be safe for them to return home.

Workers should note that children may not ‘tell’ their concerns – social workers need to observe the children and notice any signs of distress. Workers need to check out their observations with children and also confer with foster carers/residential workers.

Task 2: Written Parental Agreements and Goal Setting

The aim of the parental agreements is to work collaboratively with parents. Parents value an authoritative approach which, combined with warmth and understanding, can help them to build up their self-confidence.⁴² This is important since parents have reported not understanding what they have to do in order for a child to be returned home and how judgments will be made. They describe being confused by being given mixed messages about how well they are doing.⁴³

It is important that written agreements are used in all cases and this is particularly important for children accommodated under Section 20, as research shows that planning is poorest for them. Workers will be aware that Section 20 arrangements are voluntary, and that parents may choose to end the arrangement at any time (see page 37). Workers will set out in parental agreements for children accommodated under Section 20 what action will be taken if the voluntary arrangement is ended by the parent before the worker assesses that it is safe for the child or young person to return home.

The social worker needs to find the right balance between giving parents ownership over the agreements, whilst retaining the focus on what changes need to happen for the child/ren to be returned home.

Case supervisors need to offer support and critical challenge to make sure that agreements are clear for parents and goals are genuinely SMART. Annex 7 provides a Parental Agreement and Goal Setting Template for social workers to use and adapt.

⁴² Boddy *et al* (2013).

⁴³ Davies and Ward (2012).

Social workers will complete the following tasks:

- Use the written parental agreements to **explain and agree the changes** that are needed for reunification to take place, based on the assessment.
- Work with parents to set **SMART** (Specific, Measurable, Agreed with families, Realistic, Timely) **goals** specifying **what** changes need to be made, how they will be **evidenced**, the **timescales** and the ways in which they will be **reviewed**.
- Discuss support services with the parents and put in place a **bespoke package for parents and children** (see Tasks 3 and 4). Parents should be supported to identify the sort of help they will need to overcome the difficulties that led to their child becoming looked after⁴⁴ and what they would find helpful in making and maintaining changes. It is important that services are both available and acceptable to parents and/or older children.
- **Record the services** that will be provided to the parent in the written agreement. These should include support provided by the worker and team, other children's services workers and services like drug and alcohol and mental health services and parenting support.
- Explain to parents that **'no change'** – where changes have been identified as being required and where support has been offered – will be considered as a risk factor.
- Explain to parents the **consequences of breaching the agreements**, using the Risk Classification Table.
- Give a **signed copy of the agreement** to the **parent/s** and keep a copy on the child's case **file**.

Goal setting

Annex 7, on Written Parental Agreements, provides a template for setting and reviewing goals. Annex 8 contains information on techniques to scale goals and record and review expected outcomes.

The rationale behind goal setting – why are goals important?

Goals serve important functions for both parents and workers.

For **parents**, setting goals **collaboratively** with their social worker:

- helps parents to feel **involved**, rather than 'done to'
- helps them to **focus** on particular aspects of their behaviour that need to change
- **reduces ambiguity** and confusion
- helps them to consider what is **achievable**
- increases the **likelihood** that they will change
- has **positive therapeutic value** – when families recognise that they have been able to achieve a goal, this can lead to an increase in self-efficacy and hope, and support ongoing change
- brings **structure** during periods of crisis and chaos.

For **workers**, setting goals:

- supports **focused visits and contacts**
- promotes **planned, reflective** practice
- **ensures clarity about which services are needed to help parents achieve these goals**
- supports **Team Around the Family working** – including the informal support network – as the Team Around the Family can work together to support families to achieve the goals.

44 Thoburn *et al* (2012).

How should goals be set?

Social workers need to:

- Agree **overall objectives** with the parents (guided by the worker's understanding of the reasons for parental difficulties which will have emerged from the assessment) and then
- Set '**staged goals**' as steps towards these objectives.
- Ensure the goals are **SMART**
 - Specific
 - Measurable
 - Agreed with Families
 - Realistic and
 - Timely
- Express the goals in **language suggested by parents** so that parents are clear about what is expected of them.
- Define with parents what you both **expect will be achieved**, what would be better than expected, and what would be worse than expected, for each goal set (see Annex 8).
- Set **timescales** for goals to be achieved and progress to be reviewed.

How should goals be reviewed?

Social workers need to:

- Regularly monitor** progress.
- Be mindful of the **barriers** stopping parents from achieving the goals (which may be influenced by internal or external factors).

- Provide **support** and encouragement to parents throughout.
- Review the **effectiveness of the support and services** offered to parents.
- Recognise the **significance of reaching a goal** – for example, through using certificates of achievement – and that this may support a desire to achieve another or bigger goal.
- Be aware that **compliance with services** in itself does not constitute readiness or capacity to change, nor does it demonstrate actual change. Compliance can be seen as parents' stated *intention* to change, but is not necessarily linked to actual achievements. For example, parents may attend a parenting course and may try to implement their learning, which would be positive and show motivation to change. However, if this is not actually effective in addressing the identified problems in their parenting, it cannot be described as protecting the child from risk.
- Be flexible:** vulnerable families often suffer crises or the work can bring additional disclosures that may mean that goals need to be reviewed or new goals discussed and agreed, although the overall objective may remain consistent.
- Be aware that longer-term change requiring ongoing support may not be achieved within the child's timeframe.** Social workers need to be prepared to discuss and manage failure by families to achieve the goals set. Where goals which were set, understood and agreed with the family and the multi-agency network are *not* achieved, this may provide evidence of a family's inability to change as needed.

Tasks 3 and 4: Support and services for parents and children

Alongside the goal setting, the worker will work with the children, parents, foster carers/residential workers, schools, the wider social network and other agencies to coordinate **a package of support**. The support will be based on the specific needs of the family, identified throughout the **assessment**, and the worker's and parents' **understanding** about which services and support have been effective or ineffective in the past and their views of what might help them.

For those children who do return home, ongoing support and services for them and their parents will be critical and the support packages will be reviewed and adapted to meet the needs of the families (see Stages 4 and 5 below).

Please note that regulation and guidance which applies to children under Section 20 arrangements who return home, states that “Where a child who is not an eligible child ceases to be looked after because they return home, the child will be a ‘child in need’ and a plan must be drawn up to identify the support and services which will be needed by the child and family to ensure that the return home is successful” [Regulation 39]⁴⁵ See Annex 10 for more information.

Key messages from research about support and services

- The **combination** of relationship-based **support** (from the child's worker), **specialist services** and **informal** support for parents and children prior to and after return home can be the key to successful reunifications.⁴⁶
- **Purposeful social work** comprising the following elements, together and separately enhance the chances of successful return home.⁴⁷
 - A **clear care plan**
 - Timely and well-attended **reviews**
 - **Proactive court process** (where appropriate)
 - **Stable and skilled care placements**
 - **Strengths-based approaches** (that are culturally responsive)
 - **Monitoring** of parents combined with listening and emotional **warmth**.
- **The involvement of specialist services for parents with alcohol and/or drugs misuse difficulties or mental health problems is essential.**⁴⁸ **As we have seen, children returned home to parents with alcohol and/or drugs misuse problems experience much higher levels of abuse or neglect than others and they have a high level of return home breakdown.**
- Services need to be started **as early as possible. Support and services will need to be at the appropriate level of intensity and duration to support and sustain changes.**
- It is important that senior managers and commissioners remove any barriers that may stop parents and children from accessing services. For example, it is important that they ensure that services like parenting support (where needed) are still available to parents when children are looked after and that services for looked after children remain available once children 'cease to be looked after' on return home.

The next section (Task 3) contains information about the kinds of support that the social worker will be able to provide **directly** to children and parents. It is followed by Task 4 which provides information for social workers to consider when **creating a team around the child and family and referring parents to specialist services**.

45 The Children Act 1989 Guidance and regulations, Volume 2: care planning, placement and case review (DfE 2015a).

46 Thoburn *et al* (2012).

47 Thoburn *et al* (2012), Child Welfare Information Gateway (2012).

48 See eg. Maluccio and Ainsworth (2003), Forrester and Harwin (2008).

Task 3: Direct social work and family support to children and parents

Cases should **remain allocated to the children's social worker** (unless there are strong reasons not to), and the **team manager** needs to ensure that the worker has **sufficient time** to support and prepare the children and parents prior to return home, and during the months following reunification.

The social worker will use the care plan and the Looked After Child Review process as the framework for deciding the plan for the child, and how this will be achieved. The review can also be used to arrange the services and support for the child and galvanise the team around the family. A family support worker may be involved at this stage. **Schools and health partners** should also be involved and personal education plans and health plans amended accordingly.

Supporting children

Returning home can be as complex and stressful for children as separation.⁴⁹ It is a major transition and children will need support to work through feelings of confusion, anger, failure and fear of subsequent rejection or maltreatment. The worker needs to emphasise to the child that if they have any concerns prior to or on returning home, they must tell them or another adult who they trust. Workers also need to understand that many children will not tell anyone their concerns, and they may express their distress through different behaviours which the worker and other professionals should be alert to. If the child has an advocate and/or a trusted adult, they should be involved in preparing the child for return home. **Foster carers and residential workers also need to be fully involved in preparing the children for return home.**

Preparation work with children could support them to identify their strengths and coping skills. Annex 12 details solution focused tools that workers can use.

Supporting adolescents

Adolescents may face a variety of risks beyond those in the home (such as peer violence or sexual exploitation), and they, their parents and foster carers/residential workers will need support to manage these risks. Adolescents will often display risk-taking and challenging behaviour (as can younger children), which may be as a result of the abuse and neglect they have experienced, their experiences whilst looked after or both. Social workers need to support young people to deal with their underlying issues and to improve the way they deal with situations before returning home. (Specialist services may be required – see below – both before **and** after children return home.⁵⁰) See Annex 14 for further information on assessing and supporting adolescents.

Informal support networks have been found to be key in supporting adolescents to return home.⁵¹ Young people in reunification studies valued support from a mentor, foster carer/residential worker, relative or girl/boyfriend. Social workers need to be proactive in helping young people to initiate a network of positive informal support that can be there for them before and after return home. Social workers should talk to young people about the risks of associating with negative peers and support them to manage these risks.

As noted at the beginning of the Framework, and on page 37, some young people accommodated under Section 20 will run home or be taken home by their parents. Working Together (2015) states that in these situations local authorities should either follow procedures for immediate protection, or conduct an assessment under the Children Act, whilst the young person is at home. The Framework can support local authorities to fulfil these duties.

49 Bullock *et al* (1998).

50 Thoburn *et al* (2012).

51 Quinton (2004), Farmer and Wijedasa (2013).

If a child on a care order runs home or is taken from their placement by their parents, contrary to their care plan, workers need to follow the statutory guidance relating to looked after children.

Supporting the relationship between the child and the parent

A key role is work on the parent-child relationship which may have been difficult and will also have been affected by the child becoming looked after and may need to be repaired. Workers need to be aware and prepare parents for the fact that children may miss foster carers/residential workers and may also miss the creature comforts and other advantages of being in a placement, such as involvement in activities or a busy family life.

Contact

Contact can be used to improve parent-child interactions,⁵² support attachment, maintain relationships and sense of identity,⁵³ assess and improve parenting, and to create an easier transition for the child. Workers can support parents before and after each visit, helping them with a greeting and goodbye ritual and planning activities to do with their child/ren during the session. Social workers should take a flexible approach to contact, according to the wishes of the child, and the stage of the return home process. The venues for contact and whether or not contact needs to be facilitated, supervised, observed or recorded can be adapted for each case. Contact arrangements will be included in the care plan.

Facilitating positive contact and relationships between **fathers** and their children in care can be important in making return to a separated father a viable possibility.⁵⁴

Supporting parents

For families with complex needs, high-intensity, relationship-based social work alongside multi-disciplinary team-around-the-family approaches, provided for as long as needed, can help motivate parents to meet the needs of children returning home from care. The importance of social workers' empathy for parents whose child has needed to be looked after cannot be overstated. This support could be provided by the children's social worker, or allocated to a family support team, in which situation the social worker needs to maintain close links with the family support service.⁵⁵ Parents may need particular help in rebuilding relationships with a child with whom they have not bonded and/or if the child has been looked after from a young age. There need to be opportunities for parents and children to play, talk and take part in activities together, which will also help to rebuild their confidence as parents.

Research suggests several approaches which are associated with successful reunifications:⁵⁶

- **Intensive outreach work and family-centred work** designed around the special needs of parents of looked after children.
- Social work approaches that incorporate **crisis intervention theory** are often appropriate at the time of and shortly after a child becomes looked after to take advantage of the impetus for change.
- **Motivational interviewing.**
- **Parent education and skill building.**
- **Cognitive behavioural therapy.**
- Involving **all family members** and addressing **parent-child interaction** and a range of **parental life skills** such as communication, problem solving, and anger control.

52 Loar (1998), Beyer (2008), Haight *et al* (2001).

53 Schofield and Stevenson (2009), Boddy *et al* (2013).

54 Broadhurst and Pendleton (2007) cited in Thoburn *et al* (2012).

55 Thoburn *et al* (2012).

56 Dore & Lee (1999), Corcoran (2000), Child Information Gateway (2011, 2012), Thoburn *et al* (2012).

- Helping parents to understand **child development**.
- Supporting parents to **empathise** with their children's feelings and potential ambivalence about return home. This is especially relevant for those children who have been looked after a long time, and who are attached to their placement caregivers and who will experience a move home as a loss.
- Supporting **new partners or step-parents** who don't know the children well.

See Annex 16 for more information about how the approach of the social worker can help bring about change.

Providing practical support

Most families will need practical support with issues such as: housing, benefits, budgeting, child care and schooling in the period before return home and once the child is home. Studies have shown that practical assistance is key to providing the conditions for successful reunification and has a positive impact on the parents' relationship with their social workers.⁵⁷ Workers may need to advocate for families, and can coach parents in navigating the system, giving them confidence that they can do this themselves in the future.

Supporting informal networks

Informal networks of support have been identified as important in encouraging parents to make and sustain changes after return home. Practical and emotional support from family, friends, neighbours and the community have a positive impact on the day-to-day lives of families, and help them to be resilient to challenges. Mapping and encouraging informal networks should form part of the assessment and the ongoing support for children and families.

One study⁵⁸ found that parents who were paired with other parents who had had children returned home successfully were more than four times more likely to achieve reunification than those in a comparison group. Social workers might therefore consider how to facilitate peer support for parents.

Family Group Conferencing

Social workers could consider using family group conferences as one way to bring family and friends together to plan how parents and children will be supported if the child returns home. For more information please go to www.frg.org.uk/involving-families/family-group-conferences/fgc-publications-and-research. Alternatively, workers could contact family and friends directly and invite them to a meeting.

57 See e.g. Rzepnicki *et al* (1997), National Resource Center for Permanency and Family Connections (2009), Thoburn *et al* (2012).

58 Berrick *et al* (2011).

Task 4: Coordinating the Team around the Child and the Family

The social worker will coordinate a package of support and services to meet the family's specific needs. This will require skilled multi-agency coordination and this is especially crucial in cases of neglect.⁵⁹ The range of services available locally will be determined by commissioners and senior managers across children and adult social care, health, probation and the voluntary sector. However, social workers and their managers need to have an understanding about which of these services are most likely to support the changes that parents and children need to make. Workers will need to help reduce any barriers that parents and children face when accessing services. Social workers and their managers need to monitor how effective services are and feed back to commissioners if there are problems in the availability, accessibility or effectiveness of services.

Coordinating the Team Around the Child

The crucial role of placement caregivers

Research has shown that **foster carers and residential workers can play an important role in:**⁶⁰

- **preparing children for returning home,**
- **supporting the relationship between the child and their parents prior to return home and**
- **supporting parents and children before and after return home.** For example, foster carers/residential workers can mentor parents and build up their confidence in their ability to parent their child again. They can also advise

them on ways they have found to be effective in managing their child. Return home is more stable if foster carers work closely with the parents and children to bring about change, prepare children for return home, and remain available and involved after the child goes home. Sometimes foster carers provide respite care after children have gone home and this is highly valued by the children and their parents. Social workers may need to liaise with the foster carers'/residential worker's supervisors and consider their experience, skills and ability to handle these multiple roles and the possible need for additional training and/or support.

Support from schools

Where schools provide educational and emotional support to children, this can help to make returns home work.⁶¹ However, in one study, during return home 42% of the children attended school poorly, whilst 20% were excluded from school and both of these issues were significantly related to return breakdown. This suggests the importance of engaging schools and ensuring educational help is provided when needed. Schools also need to keep a careful eye on how children who have returned home are doing and provide emotional support to children who need it. This can be provided by the year head, assistant head, school counsellor or whoever is best placed to help. Children may also need help to revive old friendships and make new ones, since in one study just under half of the children had not been able to maintain contact with all their friends whilst they were looked after and half lacked strong friendship networks during the returns home. Schools also play a very important part in monitoring children after they return home.

59 Thoburn *et al* (2012).

60 See eg. Child Welfare Information Gateway (2006, 2011), Thoburn (2009), Fernandez and Lee (2011).

61 See eg. Taussig *et al* (2001), Sinclair *et al* (2005), Stein (2009).

Specialist support for children and young people with behavioural and/or emotional difficulties

Return breakdown is often caused by children's behavioural and/or emotional difficulties and it is crucial that children and parents are supported to address these issues before these children return home. Social workers need to liaise with CAMHS and other health and well-being providers about the services they can offer. Work on parental ambivalence about these children returning home may also be needed.

Services for children *and* their parents, targeted at improving the behaviour of the young person, parental understanding and management skills and relationships within the family are likely to be beneficial. Research suggests that it is important for foster carers/residential workers to work alongside social workers, therapists and family support workers as key members of the Team Around the Child, modelling good parenting practice and a consistent behaviour management approach to the parents.⁶² Direct work with children and young people needs to continue **after** they return home.

Coordinating the Team around the Family

Multi-agency working

There needs to be a good working relationship between children, adult services, health education, housing and other relevant agencies at all levels and a shared vision of the goals that need to be achieved with families. Strong communication between colleagues across services should help keep the focus on the needs of the children.

Parenting programmes

Parents who have abused/neglected their children are most likely to benefit from **intensive multi-faceted programmes, alongside longer term support from children's services.**⁶³ Barlow and colleagues' research⁶⁴ showed that:

'parenting programmes that incorporate additional components aimed specifically at addressing problems associated with abusive parenting (e.g. excessive parental anger, misattributions,⁶⁵ poor parent-child interaction) may be more effective than programmes that do not.' (2008 p. 9)⁶⁶

Other elements of effective parenting programmes include: providing opportunities to practise new skills, using interactive training techniques and involving fathers.

Alcohol and drugs misuse

Social workers need a sound understanding of **substance misuse (i.e., alcohol and/or drugs misuse)**, its impact on children and the factors likely to support sustained change. They need to ensure that their assessments about prognosis are not overwhelmed by 'misplaced optimism'.⁶⁷ Social workers should set clear expectations that substance misusing parents will be required to undergo treatment before children are returned home to them and that their substance misuse will be closely monitored and reviewed before and during return home. This is crucial in view of the **strong links between substance misuse and both re-abuse and neglect and return breakdown.**

62 Thoburn (2009).

63 Ward *et al* (2014).

64 Barlow *et al* (2008).

65 An example of a misattribution is a mother who does not recognise that her baby is crying because she is tired and has missed her nap, but instead believes her baby is simply uncooperative or is misbehaving.

66 Some parenting programmes include modules that specifically address abuse and neglect, including Triple P, The Incredible Years, and Parent-Child Interaction Therapy.

67 Forrester and Harwin (2004).

Evidence suggests⁶⁸ that the most effective outcomes can be achieved through a combination of the following:

- **drug and alcohol treatment services** (some suggest using increasing levels of coercion, since without the imposition of requirements to become involved in treatment, many parents are unlikely to do so.)
- **appropriate goal setting with parents** designed around the specific needs of the parents while **working with the family in a holistic way**
- **mental health services**
- **physical health care services**
- **practical support** including advocacy with the agencies responsible for housing, financial advice and therapeutic services
- **parenting services**
- **parenting peer support**

Studies show that substance misusing services in the absence of other supportive services may be insufficient to address the needs of these parents.⁶⁹

NICE guidelines indicate which interventions are most likely to be effective for people with different types of problems. For example, alongside a number of other effective interventions, detoxification programmes are recommended for substance misusers who 'have expressed an informed choice to become abstinent'.⁷⁰ These are generally thought to be effective when offered for up to twelve weeks in a community setting, although up to four weeks detoxification in a residential setting is

more effective for people who have significant co-morbid physical or mental health problems or who require concurrent or sequential detoxification from more than one substance. Following detoxification, six months continued treatment, support and monitoring should be offered, to avoid relapse.⁷¹

Domestic abuse

Victims of domestic abuse can benefit from advocacy and support which builds self-esteem, coping and decision-making.⁷² Recent reports and guidance show the merits of linked services for children and parents which work to strengthen the relationship between the child and their primary carer and address the impact that domestic abuse can have on parenting.⁷³ Arguments have been made in support of responses that work with each parent.⁷⁴ Workers need to be aware of bi-directional violence (where both parents are violent towards each other, sometimes fuelled by misuse of alcohol or drugs) and of child/adolescent to parent violence.⁷⁵

Mental health

Mental health services before and after return home are essential and can make the difference to whether or not the return home works. This relies on strong partnership working between the child's worker and the parent's mental health worker. Mental health workers need to be fully aware that children are about to be returned home to the parent and maintain/increase their support accordingly.

68 See eg. Maluccio and Ainsworth (2003), Biehal (2006), Choi and Ryan (2007), Grella *et al* (2009), Thoburn *et al* (2012), Harwin *et al* (2013 & 2014) (about FDAC, the Family Drug and Alcohol Court)

See also: http://www.iriss.org.uk/sites/default/files/iriss_leading_for_outcomes_parental_subs.pdf. and NSPCC resource for professionals on working with substance misuse, NSPCC inform – 'learning from serious case reviews' about substance misuse http://www.nspcc.org.uk/Inform/resourcesforprofessionals/scrs/briefing-substance-misuse_wda99489.html#family

69 See eg Maluccio and Ainsworth (2003), Choi and Ryan (2007), Grella *et al* (2009).

70 NICE (2007, p.7), CG52.

71 NICE (2007), CG52.

72 Ward *et al* (2014 p. 125).

73 CAADA (2014), Guy *et al* Early Intervention Foundation (2014), NICE public health guidance 50 (2014) (note recommendation 11).

74 Peckover and Everson (2014).

75 See eg. Selwyn *et al* (2014).

Research suggests that two of the most effective approaches to addressing mental health difficulties are:

- parenting-focused interventions
- cognitive behavioural therapies⁷⁶

There is increasing focus on working with both the parent and the child.^{77,78}

Physical health

A report on Family Intervention Projects⁷⁹ (FIPs) showed that families had significant and varied health needs, including basic family

and child health issues, and a high prevalence of major chronic physical conditions, as well as mental health problems.

Underlying health problems were often a key influence on families' wider difficulties. There is therefore a need to identify family health needs, signpost and refer to health and related agencies and advocate for families to secure engagement with health and related services.

Task 5: Contingency planning

The social worker will monitor progress against the agreed goals throughout Stage 3.

It cannot be assumed that planned returns home will happen, or that they will be successful. Workers will be carefully managing the risks and the care plan will need to include alternative permanence plans should the reunification not go ahead. This is especially important for any high risk cases for whom Stage 3 may represent a 'last chance' for parents to evidence change in the timeframe of the child. This is a very sensitive area of practice and **workers need to ensure that parents** (and children where possible) **understand** how decisions will be taken – through the review process with the Independent Reviewing Officer – and **what the alternative permanence plans are likely to be if they do not change sufficiently** or in time to meet the child's timescales.

Social workers will be aware that parents and children may be reluctant to confide in them about their concerns about reunification and any problems they may be facing in reaching their goals. Social workers need to talk to parents openly about this dynamic between

them and should explain to parents that telling the social worker about difficulties and/or asking for support will be viewed positively. Social workers should be aware that parents and children may still prefer to talk to other professionals, for example family centre staff, and mechanisms should be in place in order for any safeguarding and child protection concerns to be reported back to the social worker.

By the end of Stage 3, children and parents will have received services and support to address the risk factors identified in the assessment. **The parents' response to the support and services offered, and their progress in achieving their goals, provides the worker with evidence of their capacity to change** and to care for their child. This information, collected and analysed throughout Stage 3, will now be used to reclassify the risks and make a recommendation (or not) for reunification in the child's care plan. This will be shared with the Independent Review Officer for consideration and decision at the review.

76 Bee *et al* (2014).

77 Siegenthaler *et al* (2012).

78 SCIE (2009, updated 2011) <http://www.scie.org.uk/publications/guides/guide30/index.asp>.

79 Boddy *et al* (2012).

Stage 4: Reclassification of risk, decision-making and planning for reunification

The aims of Stage 4

The aims of Stage 4 are to use the evidence gathered in Stage 3 to reclassify risk and make a decision about reunification, using the Risk Classification Table (see Stage 2). For those cases where reunification is agreed, the social worker will make a Reunification Plan (either using the form in Annex 9 or integrating this information into existing plans). For those cases where reunification will not be possible, workers should follow the suggestions in Stage 2 Task 4.

Stage 4 Tasks

The social worker will complete the following tasks:

- Task 1: Reclassify risk** (including re-administering the standardised measures if used) and **decide on reunification** (with the team manager)
- Task 2:** Update the **Parental Agreements, goals and support plans**
- Task 3:** Agree a **multi-agency Reunification Plan**
- Task 4: Prepare** children and parents for return home

Task 1: Reclassification of risk and decision on reunification

Over the course of Stage 3, social workers will have gathered evidence of parents' ability to make and sustain changes, and to provide loving and safe care to their children. Together with parents, older children and key members of the kinship network, they will have identified the social work, support and services needed to maximise the chances of a safe and stable return home. The child's social worker and their manager – with input from foster carers, residential staff, family support workers and other key members of the team around the family – will agree a reclassification of risk, using the Traffic Light Tool. Decisions will be made using the care planning process. Workers should remember that **evidence of actual and sustained changes** rather than an apparent willingness to change is needed for reunification.

Workers will apply their professional judgment and experience when using the traffic light tool. Cases initially classified as **high** risk should be reclassified as **severe** if there has not been sufficient change. (For those cases where reunification will no longer be possible, workers can refer to the relevant section of Stage 2 of the Framework.)

If there has been sufficient progress to reduce the risks from **high** and increase the protective factors, they can be reclassified to **medium**. If the child's timeframe allows, reunification may now be considered.

Cases which were at a **medium** level of risk may now be re-classified as **low** risk if there is sufficient evidence of change. **Plans for reunification can then continue /begin.**

If there has not been sufficient change in **medium** level cases, the worker will decide whether to allow more time (if this fits with the child's timescale), or to escalate the risk to **high**.

Workers should note that these timescales are indicative – they should exercise judgment and take account of the age and circumstances of the child. For very young children delay in determining the action that needs to be taken can be particularly harmful.

The social worker will explain to parents that the assessment of risk remains live and continues until the risk is classified as low, and remains so for at least six months.

A note about relapse

Experts in human behaviour change consider relapse to be a natural and inevitable part of the recovery cycle. The definition '*to deteriorate after a period of improvement*' is applicable to parents learning new parenting skills, as well as those overcoming addictions. Social workers should be looking for evidence of a general trajectory towards sustained changes. They and the parents should expect and plan for some relapse (especially in the early stages of recovery) and not see it as failure.⁸⁰ However, children should only return home once the likelihood of relapse and the risks associated with harmful parenting can be managed and necessary support and services can be put in place.

80 Ward et al (2014).

Task 2: Updating the Parental Agreements, goals and support plans

As in Stage 3, the social worker will communicate the risk classification and reunification decision to the children and their parents. The parental agreements and goals used throughout Stage 3 will be updated at this point with a focus on the reality of reunification happening. The worker will discuss support needs with parents and children, and explain that they will create a reunification plan.

Support for reunification

Many of the services and support put in place in Stage 3 should remain. However, some adaptations to the support plans will need to be made as parents and children face the reality that they will now be living together again.

Role of foster carers/residential workers

Social workers (and parents) need to understand and manage the impact on the child of leaving their care placement, especially if they have built up an attachment to their foster carer/residential worker. In some cases it may be beneficial for the social worker to arrange for the foster carer or residential setting to provide ongoing support and potentially respite care once the child has returned home. Support for maintaining contact with foster families may also be useful.

School

The social worker needs to involve schools in providing support to children prior to and after return home and to ensure appropriate educational help is provided. If the child will change school when they return home, then assistance with integration into a new school is needed. This is especially important as it has been found that there are high levels of poor school attendance and school exclusion after return home, and these are related to return breakdown. The Virtual School Head should be involved in supporting the child in relation to return home and this should be reflected in the Personal Education Plan. Schools also play a crucial role in monitoring children after return home.

Task 3: Agreeing the Reunification Plan

The local authority is required to outline the assessment of the support and services needed for a child returning home and their parent/s in the Child's Care Plan. We have provided a Reunification Plan Template to support a multi-agency agreement setting out the roles and responsibilities of the various agencies involved in supporting the parents and the children in relation to return home. The information in this template can be included in the child's Care Plan, and/or any Child Protection Plan or Child in Need Plan which will be required at this stage.⁸¹ It should be linked to the Personal Education Plan and Personal Health Plan.

As stated before, parents of children accommodated under Section 20 may not follow the plans. In these cases, the local authority will decide if a further assessment of the needs and safety of the child is warranted.

Annex 9 provides the template for workers to use and adapt.

This next section contains suggestions about what and who to include in the Reunification Plan.

Who should be involved in the Reunification Plan?

- Parents, children, foster carers/residential workers, schools and other key staff supporting the family. The plan needs to **detail the role and responsibilities of relevant practitioners** working with the child and the family, setting out who will lead different areas of activity.
- The social worker needs to arrange a **meeting** with all the relevant professionals to back up the plan and ensure commitments by the various agencies.

- Any new specialist **referrals** required need to be clearly identified and agreed during this meeting.
- The plan should be **signed** by the nominated officer in accordance with the Care Planning and Fostering Regulations (2015), with a copy provided to all the agencies involved.

Outlining the support for children and parents before and after reunification

- The plan will consider the role of the **informal support network** around the family – and especially around teenagers returning home.
- Social workers need to arrange an **appropriate level of support**, which recognises the difficulty of return home for parents and children.
- Workers should be mindful not to 'prop up' a family if they are unlikely to be able to meet the children's long term needs for safety and stability without intensive support. However, disabled children and parents are likely to need services sometimes long term, more often episodic, to be called on when needed. The plan should state **how long** services will be provided for, and at what level of **intensity** (subject to review).
- Parents and children need to be **clear that they can access support and services if additional needs arise** and how to do so.
- Where children face risks from outside the home, the plan needs to include the key agencies responsible for the environments where abuse may occur. For example, if a young person is moving back into an area where they experienced sexual exploitation, the police need to be involved in the planning and support arrangements.

⁸¹ For further information see the latest Children Act 1989: care planning, placement and case review statutory guidance; the IRO Handbook (DCSF 2010) and Working Together (HM Government 2015).

Timescales for reunification and case review

- The plan should set out the precise **timescale** within which it is expected that reunification will take place. Consideration needs to be given to school holidays and exam periods (of all the children involved) to minimise any disruption. Extended contact should happen during term times as far as possible, as schools can monitor children and provide extra support. However, it may sometimes be better for full-time return home to happen in school holidays to fit with changes in school when they occur.
- The plan should clearly state how the safety and welfare of the child will be regularly **monitored and reviewed**. It should state that the risks can be reclassified at any time, and that action may be taken if parents are unable to sustain changes and provide sufficiently for their children.
- Reunification Plans need to set out clearly the dates when the reunification plans will be formally reviewed.

Good practice suggests that the local authority will continue to provide appropriate support and services with families for a period of time following reunification. However, some families, where the child ceases to be looked after, may refuse services and it is then up to the social worker to assess whether the child is at risk of significant harm.

Task 4: Preparing children and parents for reunification

When preparing families for reunification, workers need to be aware of and discuss the following issues with children and parent/s.

Preparing children

Return home is a major transition

A child's return to the family involves a major transition in which the child's relationships and roles at home and possibly school have to be renegotiated.⁸² The children bring with them their experience of loss as a result of disruptions in their relationships with their parents and siblings and foster carers/residential staff. They may be returning to changed families. Returning home may re-trigger the trauma of earlier abuse and neglect.

Bedrooms

It is important for children who have lived away to feel that they still have a place in the family home. For some children this will mean seeing that their bedroom is the same, and that their possessions are still there. If the family has moved whilst the child has been looked after, then children should see their bedroom before they stay the night, and social workers should encourage parents to ensure it is welcoming, and invite children to make their mark on their bedroom in some way.

Changes in the family

Efforts need to be made, from the start of the care placement, to maintain the children's roles in their families, so that the family does not assume a way of functioning which excludes them.⁸³ Even if return home seems unlikely, working with parents about how longer-term links can be maintained is an essential role for the social worker.

82 Bullock *et al* (1998).

83 Thoburn (1994), Bullock *et al* (1998).

Sometimes a new baby has been born while the child was looked after or new step-siblings have joined the family, if the child's parent has a new partner with children. This is likely to make it more difficult for the child to adapt back and s/he may be resented by the children who are already there. Discussion of **all** the children's needs and likely reactions is important and all children in the family should be involved in the work to achieve a successful return home. Research shows that reunifications more often succeed when children return home with their siblings.⁸⁴

Children may also have to deal with their parent having a new partner. The relationship between the parent's partner and the children should have been covered in the assessment, so children will have been asked how they get on with new partners (who may be a positive or negative influence) and these relationships will have been assessed during contact, whilst the child was still looked after.

Workers need to talk to children about how they feel about all the changes in their families before they go home, and once they are living at home again. Children may not always 'tell' – so workers should be alert to children's behaviour and respond accordingly.

Continuity

It is very important if possible for social workers to arrange, when the child becomes looked after, for children to stay in the same school or day nursery. This will pay dividends when the child returns home as it provides much-needed continuity for children, who have to deal with so many other changes when they move from care to their families.

Preparing parents

Parents need to be aware that children may be anxious that the return home will not work, worried that parental difficulties will recur, jealous of siblings or newborn babies in the family and that they are likely to miss their foster carers. Younger children may

continue to refer to former foster carers who have become their main attachment figures as 'Mummy' and 'Daddy' and parents may find this difficult to understand, when they themselves have worked so hard to get their children home. Younger children may show their distress in behaviours such as defiance, jealousy and nightmares.

Parents too often have doubts about children returning home from care and worry about their ability to cope. Parents may also need help to instil and maintain hope that they can cope.⁸⁵ Preparation for parents should include what to expect when children return home and the fact that returns often start well with a honeymoon period. There may then be a major row (with children or between parents) where all of the hurt feelings are expressed. Reunification involves facing up to the failures on either side which led to separation. Overcoming this apparent crisis, when children need reassurance that they will not be rejected again, can lay the foundation for a successful return home.⁸⁶

Since parents are often taken by surprise by the difficulties that their children have in settling back with them (which frequently have not been revealed during overnight and weekend stays), practical help and advice on how to deal with these behaviours is needed from social workers and other professionals, during the return home process as well as afterwards, as well as **reassurance in advance that such difficulties are to be expected**. Parents should be encouraged to talk about any difficulties with professionals and it should be explained that asking for support will be seen as positive by professionals.

By the end of Stage 4, firm plans will be in place for those children who are returning home to their parents. The Written Parental Agreement will describe the progress that the parents need to sustain, and the reunification plan will detail the support that will be offered, when and by whom. Stage 5 sets out the final steps involved in supporting children and parents on return home.

84 Thoburn (2009).

85 Petras *et al* (2002).

86 Bullock *et al* (1998).

Stage 5: The return home

The aim of Stage 5

The aim of Stage 5 is to detail the final preparation and transition period leading to a child returning home full time. The support and services discussed in Stage 3 were focused on getting parents to a place where reunification could be *considered*. In Stage 4 the parental agreements and goals are updated and workers create the multi-agency reunification plan (as part of the care plan). The onus in Stage 5 is on supporting parents and children in the immediate reality of return home. Some of the services and support put in place in Stages 3 and 4 will continue, but workers should review the support packages and consider what else may need to be provided to enable a smooth transition home. It is important to keep services going at a high level at the beginning of the return home, as parental stress is likely to increase as they are getting to know their child again and the child may test out their commitment.

The following pages set out a useful approach to supporting children and parents post reunification. Workers need to think about the most effective ways to support families, depending on their circumstances. As has been noted, some families may decide not to accept further help once the children have returned home and authorities need a clear plan about where they can and cannot intervene.

Stage 5 Tasks

The social worker will complete the following tasks:

- **Task 1:** Increase **contact** and organise a **gradual return home**
- **Task 2:** Coordinate **support and services** as detailed in the **Reunification Plan**
- **Task 3: Monitor and review** post return home
- **Task 4: Reclassify risk**

Task 1: Increase contact and gradual return home

Research evidence and feedback from children and parents highlight that the return home process should be gradual.

Children need to be consulted about the timing and manner of return home. Daytime unsupervised contact between children and their parents can be slowly increased, as the family build up to the first overnight stay. Schools can monitor how the child is managing these contacts. Workers need to talk to children about how contact is going and about their hopes and fears about returning home and how to get help if things do not turn out as they hope. After a few good mid-week overnights, plans can be made for weekend nights, building up to whole weekends. Workers need to arrange to make home visits during the child's first visits home – both scheduled and unannounced.

Critical post 'honeymoon' period

Once children are living at home again, parents may need practical help and advice from workers and other professionals, on how to deal with children's emotional distress and behaviour, as well as reassurance **beforehand** that such difficulties are to be expected. Some parents interviewed in research studies would have welcomed the chance to speak to other parents who had been through similar experiences. Parents also wanted **access to a crisis service** so that they would know that they could telephone to get **help from someone familiar** at any time of the day or night.

Task 2: Coordinate support and services as detailed in the reunification plan

As previously noted, services need to continue after the child has returned home and more intensive help may be needed in the early stages of reunification and episodically when stresses arise. These services should reflect the individual needs of each child and family and be detailed in the Reunification Plan. Research suggests that post-return support and services which address the following issues can prevent reunifications breaking down:

- Enhancing parenting skills
- Providing social support for parents
- Connecting families to basic resources
- Addressing children's behavioural and emotional needs.⁸⁷

Research strongly suggests that in many cases post reunification services need to continue for at least 12 months after return home and, as previously noted, should be planned before return home takes place. Six months may be adequate for some low risk cases, and workers should use their judgment.

Swift withdrawal of services and early case closure happens frequently when children are returned home. However, this should be avoided, since when cases are closed despite continuing concerns the reunifications more often break down.⁸⁸

87 Freundlich and Wright (2003), Child Welfare Information Gateway (2012).

88 Thoburn (2009).

Task 3: Monitor and review once a child has returned home

Once a child has returned home, social workers will arrange a schedule of visits – both arranged and unannounced. Other children's services staff, such as family support workers may provide some of this support – this will be detailed in the Reunification Plans. The worker will ensure that other agencies such as schools, health visitors and nursery staff will provide monitoring and supervision of the child and when this is done, returns home are more stable. The social worker will review progress made against the goals set in the parental agreements, and assess the effectiveness of the services and support provided, making any necessary changes to the Reunification Plan. The worker should use the goal-setting and review process to build on the strengths of the family and try to boost the confidence of the parent/s.

The social worker must see the child alone, and some of the time this should be out of the home, to ascertain their views and experiences of returning home.

Social workers should anticipate that children (and parents) are unlikely to be totally open about their difficulties and need to combine *'respectful vigilance with persistence and resourcefulness in their attempts to help'* and monitor the children.⁸⁹ Whilst the worker needs to try and create the relationship and conditions for a child to trust them, they should also observe the behaviour of the child and talk to others who see the child in other settings, such as at school. The worker will be considering the quality of the child's relationship with each of the parents (or

parent figures eg. parent's partner or step-parent) at home. It is of concern that one study found that a third of the children were not close to either parent after return home. If serious parental difficulties re-emerge and/or children's needs are not being met, workers will need to consider whether or not the child's needs can be met whilst with their parent/s.

There is a need for ongoing assessment of the family's needs as the full extent of many difficulties and their need for assistance may not become apparent until some time into the return home.

Research shows that decision-makers tend not to alter plans once reunification has been agreed and are slow or reluctant to act on incidents of abuse, once children have returned home, even when significant problems occur.⁹⁰ Over-optimism by workers and passive case management have been highlighted in reviews of child death cases. It is therefore important that a full record of all referrals about the child and all incidents of maltreatment, and how they were dealt with, are kept and discussed at each review and that every incident is met with appropriate action to keep children safe.

It should be noted that if things go wrong they sometimes go wrong quickly – in one study⁹¹ one third of returns home broke down within **three months**, another third within **six to nine months** and the rest within two years. From the start of the return home, workers therefore need to monitor cases closely, be alert to risks re-emerging and take prompt protective action when necessary. All the individuals supporting families before and after return home need to encourage parents and children to seek additional help at times of stress.

89 Thoburn *et al* (2012, p.13).

90 Davies and Ward (2012), Thoburn *et al* (2012).

91 Wade *et al* (2011).

Task 4: Reclassification of risk

The worker and manager should formally reclassify the risks again 6 months after the child has returned home. The case needs to remain active until parents have maintained a **low risk classification** for at least **6 months**. Once this has been achieved, the social worker can consider ending this aspect of the case. Any withdrawal of support for children and parents needs to be tapered

and gradual, with contingency plans in place to 'step up' services if parents or children request it, or if there are signs that stresses may result in family breakdown or the child's needs not being adequately met. Social workers may then want to maintain some 'step down' services to provide some lighter touch monitoring and support for a time-limited period. It is also important that parents and children know that they can request help again at any time and are given phone numbers to call so that they know how to do this.

This completes the final stage of the Practice Framework. By this point, the social worker and key colleagues will have worked closely with the parents, child and foster carers/residential staff and will have: conducted a robust assessment, classified the risk involved in return home several times (depending on the case), written a Return Home Assessment Report, set and reviewed goals, agreements and plans, and designed and delivered packages of support, services and monitoring.

The workers and manager will have applied the **key messages from research** alongside their **professional judgement** and **core social work skills** in executing these tasks.

The Reunification Practice Framework aims to support workers to make decisions that mean that children only return home when it is safe for them to do so. The assessment process, agreements, goals, support and services should give parents appropriate opportunity to demonstrate their capacity and willingness to change. For those parents unable to change within the timescales for their child, the Framework should have provided clear evidence to show that reunification should not be considered, and alternative permanence arrangements should have been made for the child. For those children who do return home, the Framework should have enabled parents and children to be prepared and supported, thereby increasing the chances of the child experiencing a safe, stable and nurturing life at home.

References

- Alderson, S., Westmarland, N. and Kelly, L. (2013) 'The Need for Accountability to, and Support for, Children of Men on Domestic Violence Perpetrator Programmes', *Child Abuse Review*, 22, pp. 182–193.
- Barker, D., Bryan, A. and Davis, E. (2014) *Introductory Guide to Completion of Parenting Assessments*, Bristol, Bristol Council.
- Barlow, J., Johnston, I., Kendrick, D., Polnay, L. and Stewart-Brown, S. (2008) 'Individual and group-based Parenting Programmes for the treatment of physical child abuse and neglect (Review)', *The Cochrane Library*, Issue 4.
- Barlow, J., Fisher, J. and Jones, D. (2012) *Systematic review of models of analysing significant harm*, Research Report DFE-RR199, London, Department for Education.
- Barnett E., Sussman S., Smith C., Rohrbach L. and Spruijt-Metz D. (2012) 'Motivational Interviewing for Adolescent Substance Use: A review of the literature' *Addictive Behaviours*, 37 (12), pp. 1325–1334.
- Barter C., McCarry M., Berridge D. and Evans K. (2009) *Partner exploitation and violence in teenage intimate relationships*, University of Bristol and NSPCC, www.nspcc.org.uk/inform
- Bazalgette, L., Rahilly, T. and Trevelyan, G. (2015) *Achieving emotional wellbeing for looked after children: a whole system approach*, London, NSPCC.
- Beckett, H. with Brodie, I, Factor, F, Melrose, M, Pearce, J, Pitts, J, Shuker, L and Warrington, C. (2013) "It's wrong - but you get used to it": a qualitative study of gang-associated sexual violence towards, and exploitation of, young people in England, University of Bedfordshire.
- Bee, P., Bower, P., Byford, S., Churchill, R., Calam, R., Stallard, P., Prymachuk, S., Berzins, K., Cary, M., Wan, M. and Abel, K. (2014) *The clinical effectiveness, cost-effectiveness and acceptability of community-based interventions aimed at improving or maintaining quality of life in children of parents with serious mental illness: a systematic review*, NIHR, Health Technology Assessment 18 (8).
- Bentovim, A., Cox, A., Bingley Miller, L., and Pizzey, S. (2009) *Safeguarding Children Living with Trauma and Family Violence: a Guide to Evidence-Based Assessment, Analysis and Planning Interventions*, London, Jessica Kingsley.
- Bentovim, A., Cox, A., Bingley-Miller, L. and Pizzey, S. (2010) *Safeguarding Assessment and Analysis Framework: Evidence Based Approaches to Assessing Harm, The Risk of Future Harm and Prospects for Intervention*, York, Child and Family Training.
- Berelowitz, S., Firmin C, Edwards G. and Gulyurtlu S. (2012) "I thought I was the only one. The only one in the world." The Office of the Children's Commissioner's inquiry in to child sexual exploitation in gangs and groups: interim report (pdf), London, Office of the Children's Commissioner.
- Berrick, J. D., Cohen, E., and Anthony, E. (2011) 'Partnering with Parents: Promising Approaches to Improve Reunification Outcomes for Children in Foster Care', *Journal of Family Strengths*, Vol. 11, Issue 1, Article 14. Available at: <http://digitalcommons.library.tmc.edu/jfs/vol11/iss1/14>
- Beyer, M. (2008) 'Visit coaching: Building on family strengths to meet children's needs', *Juvenile and Family Court Journal*, 59 (1), pp. 47–60.
- Biehal, N. (2006) *Reuniting looked after children with their families: A review of the research*, London, National Children's Bureau.
- Biehal, N. (2007) 'Reuniting children with their families: reconsidering the evidence on timing, contact and outcomes', *British Journal of Social Work*, Vol. 37, no 5, pp. 807–824.
- Boddy J., Statham J., Warwick I., Hollingworth K. and Spencer G. (2012) *Health Related Work in Family Intervention Projects, Final report from the Thomas Coram Research Unit*, London, Institute of Education, University of London
- Boddy, J., Statham, J., Danielsen, I., Geurts, E., Join-Lambert, H. and Euillet, S. (2013) *Beyond contact: work with families of children placed away from home in four European countries*, Working Paper, London, Nuffield Foundation.
- Bowyer S. and Wilkinson J. (2013) *Evidence scope: models of adolescent care provision*, Totnes, Research in Practice
- Brandon, M. and Thoburn, J. (2008) 'Safeguarding Children in the UK: a longitudinal study of services to children suffering or likely to suffer significant harm' *Child and Family Social Work*, 13(4), pp. 365–377.
- Brandon, M., Belderson, P., Warren, C., Howe, D., Gardner, R., Dodsworth, J. and Black, J. (2008) *Analysis of Child Deaths and Serious Injury Through Abuse and Neglect: What Can We Learn? A Biennial Analysis of Serious Case Reviews 2003–2005*, London, Department for Children, School and Families.
- Brandon M., Bailey S. and Belderson P. (2010) *Building on the learning from serious case reviews: a two year analysis of child protection database notifications 2007–2009*, London, Department for Education.
- Brandon M., Bailey S., Belderson P. and Larsson B. (2013) *Neglect and Serious Case Reviews. A report from the University of East Anglia commissioned by NSPCC*, University of East Anglia/NSPCC.
- Broadhurst, K. and Pendleton, T. (2007) 'Revisiting children "home on trial" in the context of current concerns about the costs and effectiveness of the looked-after children system: findings from an exploratory study', *Child & Family Social Work*, Vol 12, no 4, pp. 380–389.
- Broadhurst, K. and Mason, C. (2013) 'Maternal outcasts: raising the profile of women who are vulnerable to successive, compulsory removals of their children – a plea for preventative action', *Journal of Social Welfare and Family Law*, 35:3, pp. 291–304, DOI:10.1080/09649069.2013.805061.
- Brown, R. and Ward, H. (2013) *Decision-making within a Child's Timeframe: An Overview of Current Research Evidence for Family Justice Professionals Concerning Child Development and the Impact of Maltreatment*, Working Paper 16, London, Childhood Wellbeing Research Centre.

- Bullock, R., Gooch, D. and Little, M. (1998) *Children Going Home: The Re-unification of Families*, Aldershot, Ashgate.
- CAADA (Co-ordinated Action Against Domestic Abuse) (2014) Insights 2: 'In plain sight: Effective Help for Children Exposed to Domestic Abuse', Bristol, CAADA.
- Chand, A. and Thoburn, J. (2005) 'Child and family support services for minority ethnic families: what can we learn from research?' *Child and Family Social Work* 10, 2, pp. 169–178.
- Child Welfare Information Gateway (2006) *Family Reunification: What the Evidence Shows*, Washington DC, U.S. Department of Health and Human Services.
- Child Welfare Information Gateway (2011) *Family Reunification: What the Evidence Shows*, Washington DC, U.S. Department of Health and Human Services.
- Child Welfare Information Gateway (2012) *Supporting Reunification and Preventing Re-entry into Out-of-Home Care*, Washington DC, U.S. Department of Health and Human Services.
- Choi, S., and Ryan, J. P. (2007), Co-occurring problems for substance abusing mothers in child welfare: Matching services to improve family reunification, *Children and Youth Services Review*, 29(11), pp. 1395–1410.
- Corcoran, J. (2000). 'Family interventions with child physical abuse and neglect: A critical review', *Children and Youth Services Review*, 22(7), pp. 563–591.
- Davies, C. and Ward, H. (2012) *Safeguarding Children Across Services: Messages from Research*, London, Jessica Kingsley. <https://www.education.gov.uk/publications/eOrderingDownload/DFE-RR164.pdf> accessed 2 January 2016. See especially Chapter 4.
- Dawe, S. and Harnett, P. H. (2007) 'Improving family functioning in methadone maintained families: results from a randomised controlled trial', *Journal of Substance Abuse Treatment*, 32, pp. 381–390.
- Department for Children, Schools and Families (2010) *IRO Handbook: Statutory guidance for independent reviewing officers and local authorities on their functions in relation to case management and review for looked after children*, London, Department for Children, Schools and Families.
- Department for Education (2013) *Improving Permanence for Looked After Children Data Pack*, London.
- Department for Education (2014) *Children Looked After in England (including adoption and care leavers) – year ending 31 March 2014, Statistical First Release*, available online and accessed 19.10.14 at https://www.gov.uk/government/uploads/system/uploads/attachment_data/file/359277/SFR36_2014_Text.pdf.
- Department for Education (2015) *The Care Planning and Fostering (Miscellaneous Amendments) (England) Regulations 2015*, London, Department for Education. Available online at http://www.legislation.gov.uk/uksi/2015/495/pdfs/uksi_20150495_en.pdf
- Department for Education (2015a) *The Children Act 1989 guidance and regulations, Volume 2: care planning, placement and case review*, London, Department for Education. Available online at <https://www.gov.uk/government/publications/children-act-1989-care-planning-placement-and-case-review>
- Department of Health, Department for Education and Employment and Home Office (2000) *Framework for the Assessment of Children in Need and their Families*. London: The Stationery Office. (<http://webarchive.nationalarchives.gov.uk/20130401151715/https://www.education.gov.uk/publications/eOrderingDownload/Framework%20for%20the%20assessment%20of%20children%20in%20need%20and%20their%20families.pdf>).
- Department of Health, Cox A. and Bentovim A. (2000), *Framework for the Assessment of Children in Need and their Families: The Family Pack of Questionnaires and Scales*, London, The Stationery Office.
- Dickens, J., Howell, D., Thoburn, J. and Schofield, G. (2007) 'Children Starting to be Looked After by Local Authorities in England: An Analysis of Inter-authority Variation and Case-Centred Decision Making', *British Journal of Social Work*, Vol. 37, No. 4, pp. 597–617.
- Dixon J., Lee J., Ellison S. and Hicks L. (2015) *Supporting Adolescents on the Edge of Care. The role of short term stays in residential care. An Evidence Scope*, Report Submitted to the NSPCC and Action for Children. <https://www.actionforchildren.org.uk/media/5222/edge-of-care-final-report-with-annexes.pdf>
- Dore, M. M. and Lee, J. M. (1999) 'The role of parent training with abusive and neglectful parents', *Family Relations*, 48, pp. 313–325.
- Dutton D. G. and Painter S. (1993) Emotional attachments in abusive relationships: a test of traumatic bonding theory, *Violence Vict*, Summer, 8(2), pp. 105–20.
- Farmer, E., Sturgess, W., O'Neill, T. and Wijedasa, D. (2011) *Achieving Successful Returns from Care: What makes reunification work?*, London, BAAF (British Association for Adoption and Fostering, now CoramBAAF).
- Farmer, E. and Lutman, E. (2012) *Effective Working with Neglected Children and their Families: Linking Interventions to Long-term Outcomes*, London, Jessica Kingsley. Executive summary at http://www.childandfamilytraining.org.uk/sites/9/pg/69/Elaine_Farmer_Executive_summary.pdf
- Farmer, E. and Wijedasa, D. (2013) 'The Reunification of Looked After Children with Their Parents: What Contributes to Return Stability?', *British Journal of Social Work*, Vol. 43, Issue 8.
- Farmer E. (2015) *Reunification: A Research Overview*, Bristol, University of Bristol.
- Farmer E. and Patsios D. (2015) *Evaluation Report on Implementing the Reunification Practice Framework*, Bristol, University of Bristol.
- Feldstein S and Ginsburg J (2006) 'Motivational Interviewing with Dually Diagnosed Adolescents in Juvenile Justice Settings', *Brief Treatment and Crisis Intervention*, 6 (3), pp. 218–233.
- Fein, E., Maluccio, A., Hamilton, V. and Ward, D. (1983) 'After foster care: outcomes of permanency planning for children', *Child Welfare*, LXII, pp. 485–558.
- Fernandes P. (2015) *Evaluation of the Face to Face service. Using a solution-focused approach with children and young people in care or on the edge of care*, London, NSPCC.

- Fernandez, E. and Lee, J.S. (2011) 'Returning children in care to their families: factors associated with the speed of reunification', *Child Indicators Research*, Vol 4, no 4, pp. 749–765
- Festinger, T. (1996) 'Going home and returning to foster care'. *Children and Youth Services Review*, 18(4), pp. 383–402.
- Firmin, C. (2011). *This is it. This is my life...*, Female Voice in Violence, Final Report, London: ROTA.
- Forrester D. (forthcoming) 2012–14 Engaging Parents and Protecting Children? A Randomized Controlled Trial of Motivational Interviewing (MI) in Child Protection Work. From <http://www.beds.ac.uk/goldbergcentre/research/asl>.
- Forrester, D. and Harwin, J. (2004) 'Social Work and Parental Substance Misuse' in Phillips R. (ed) *Children exposed to parental substance misuse: Implications for family placement*, London, BAAF.
- Forrester, D. and Harwin, J. (2008) 'Parental substance misuse and child welfare: outcomes for children two years after referral.' *British Journal of Social Work* 38, 8, pp. 1518–1535.
- Freundlich, M. and Wright, L. (2003) *Post Permanency Services*, Washington DC, Casey Families Program.
- Goldberg, D. P. and Hillier, V. F. (1979) 'A Scaled Version of the General Health Questionnaire', *Psychological Medicine*, 9, pp. 139–145.
- Gondolf, E. W. (2002) *Batterer Intervention Systems: Issues, Outcomes and Recommendations*. London, Sage.
- Goodman, R. (1997), 'The Strength and Difficulties Questionnaire: A Research Note', *Journal of Child Psychology and Psychiatry*, 38, pp. 581–586.
- Grella, C. E., Needell, B., Shi, Y., and Hser, Y. (2009). Do drug treatment services predict reunification outcomes of mothers and their children in child welfare? *Journal of Substance Abuse Treatment*, 36(3), pp. 278–293.
- Guy, J. with Feinstein, L. and Griffiths, A. (2014) *Early Intervention Foundation Evidence*, London, Early Intervention Foundation.
- Haight, W. L., Sokolec, J., Budde, S. and Poertner, J. (2001) *Conducting parent-child visits*. UrbanaChampaign, IL: University of Illinois, Children's Research Center.
- Hanson and Holmes (2014) *That Difficult Age, Developing a more effective response to risks in adolescence*, Research in Practice and Association of Directors of Childrens' Services
- Harnett, P. H. (2007) 'A procedure for assessing parents' capacity for change in child protection cases', *Children and Youth Services Review* 29, 9, pp. 1179–1188.
- Harwin J., Alrouh B., Ryan M. and Tunnard J. (2013) 'Strengthening prospects for safe and lasting family reunification: can a Family Drug and Alcohol Court make a contribution?', *Journal of Social Welfare and Family Law*, 35:4, pp. 459–474, DOI:10.1080/09649069.2013.851244.
- Harwin, J., Alrouh, B., Ryan, M. and Tunnard, J. (2014) *Changing Lifestyles, Keeping Children Safe: an evaluation of the first Family Drug and Alcohol Court (FDAC) in care proceedings*, London, Brunel University.
- HM Government (2015) *Working together to safeguard children, A guide to inter-agency working to safeguard and promote the welfare of children*, London, HM Government. Available online at https://www.gov.uk/government/uploads/system/uploads/attachment_data/file/419595/Working_Together_to_Safeguard_Children.pdf
- Holmes, L. (2014) *Supporting Children and Families Returning Home from Care: Counting the Costs*, Loughborough University and NSPCC.
- Honomichl, R., Hatton, H, and Brooks, S. (2009) *Factors, Characteristics and Promising Practices Related to Reunification and Re-Entry: A Literature Review for the Peer Quality Review Process, UC Davis Human Services Northern California Training Academy*, Davis, CA.
- Hyde-Dryden G., Holmes L., Lawson D. and Blackmore J. (2015) *Taking Care: Practice Framework for Reunification Evaluation Report*, Centre for Child and Family Research, University of Loughborough
- Hyde-Dryden, G., Gibb, J., Lea, J., Buckley, E., Holmes, L., Wallace, E., Lushey, C. and Lawson, D. (2015a) *Improving practice in respect of children who return home from care: research report*, London, Department for Education.
- Jones, D., Hindley, N. and Ramchandani, P. (2006) 'Making plans: assessment, intervention and evaluating outcomes'. In Aldgate, J., Jones, D. & Jeffery, C. (eds) *The Developing World of the Child*, London, Jessica Kingsley. See also: Hindley, N., Ramchandani, P. G. and Jones D. P. H. (2006), 'Risk factors for recurrence of maltreatment: a systematic review', *Arch Dis Child*, 9, pp. 744–752. doi: 10.1136/adc.2005.085639
- Laming (2003) *The Victoria Climbié Inquiry: Report of an Inquiry by Lord Laming*, Cm 5730, London, The Stationery Office.
- Loar, L. (1998) 'Making visits work'. *Child Welfare*, 77, pp. 41–58.
- Maluccio, A. N. and Ainsworth, F. (2003) 'Drug Use by Parents: A Challenge for Family Reunification Practice', *Children and Youth Services Review*, Vol. 25, No. 7, pp. 511–533.
- Marcenko, M. O. and Striepe, M. I. (1997) 'A look at family reunification through the eyes of mothers', *Community Alternatives: International Journal of Family Care*, 9 (1), pp. 33–48.
- Munro, E. (1999) 'Common errors of reasoning in child protection work'. *Child Abuse & Neglect*, 23, 8, pp. 745–758.
- National Resource Center for Permanency and Family Connections (2009) *Family engagement: A web-based practice toolkit*, New York, NY. Retrieved July 2014 from <http://www.nrcpfc.org/fewpt/introduction.htm>.
- NICE (National Institute for Health and Care Excellence) (2007) *Drug Misuse – Opioid detoxification (CG52)*. Available at: <http://publications.nice.org.uk/drug-misuse-opioid-detoxification-cg52>.
- NICE (2014) *Domestic violence and abuse: how health services, social care and the organisations they work with can respond effectively*, NICE public health guidance 50. Available at: <http://www.nice.org.uk/guidance/ph50/resources/guidance-domestic-violence-and-abuse-how-health-services-social-care-and-the-organisations-they-work-with-can-respond-effectively-pdf>.

- NSPCC (2012) *Returning Home from Care: What's best for children?* London, NSPCC.
- Owen, C. and Statham, J. (2009) *Disproportionality in Child Welfare*, Department for Children, Schools, and Families, www.education.gov.uk/publications/eOrderingDownload/DCSF-RR124.pdf.
- Peckover, S. and Everson, A. (2014). 'Putting Men's Abuse of Women on the Child Care Agenda: an innovative specialist domestic abuse project', *Practice: Social Work in Action*, Vol. 26 (3), pp. 143–159.
- Petras, D. D., Massat, C. R., & Essex, E. L. (2002) 'Overcoming hopelessness and social isolation: The ENGAGE Model for working with neglecting families toward permanence', *Child Welfare*, 81, pp. 225–248.
- Platt D. and Riches K. (2015), *C-Change: Capacity to Change Assessment Manual*, Bristol, University of Bristol. Available from <http://www.bristol.ac.uk/sps/research/projects/current/capacity-to-change/>
- Quinton, D. (2004) *Supporting Parents: Messages from Research*, London, Jessica Kingsley.
- Research in Practice (2013) *Assessing Parents' Capacity to Change*, Dartington, RiP.
- Rzepnicki, T. L., Schuerman, J. R. and Johnson, P. (1997) 'Facing uncertainty: reuniting high-risk families', *Child welfare research review*, Vol 2 (ed. Berrick, J. D., Barth, R.P. and Gilbert, N.) New York, Columbia University Press.
- Schofield, G. and Stevenson, O. (2009) 'Contact and relationships between fostered children and their birth families', *The Child Placement Handbook: Research, policy and practice*, London, BAAF (now CoramBAAF).
- SCIE (Social Care Institute for Excellence) (2009, updated 2011) *Think child, think parent, think family: a guide to parental mental health and child welfare*. <http://www.scie.org.uk/publications/guides/guide30/index.asp>
- Scott, K. L. (2004) 'Predictors of change among male batterers: application of theories and review of empirical findings', *Trauma, Violence Abuse*, 5 (3), pp. 260–284.
- Selwyn J., Wijedasa D. and Meakings S. (2014) *Beyond the Adoption Order: challenges, interventions and adoption disruption*, Research report, London, Department for Education.
- Siegenthaler, E., Munder, T. and Egger, M. (2012) 'Effect of preventive interventions in mentally ill parents on the mental health of the offspring: Systematic review and meta-analysis', *J Am Acad Child Adolesc Psychiatry*; 51(1), pp. 8–17.
- Sinclair I. (2005) *Fostering Now: Messages from Research*, London, Jessica Kingsley.
- Sinclair, I., Baker, C., Wilson, K. and Gibbs, I. (2005) *Foster Children: Where They Go and How They Get On*, London, Jessica Kingsley.
- Sinclair, I., Baker, C., Lee, J. and Gibbs, I. (2007) *The Pursuit of Permanence: A Study of the English Care System*, London, Jessica Kingsley.
- Smith, K (ed.) Coleman K., Eder S. and Hall P. (2011) *Homicides, firearms offences and intimate violence 2009/2010: supplementary volume 2 to Crime in England and Wales 2009/2010*, London, Home Office
- Srivastava, O. P. and Polnay, L. (1997) 'Field trial of graded care profile (GCP) scale: A new measure of care'. *Archives of Disease in Childhood* 76 (4), pp. 337–40. For a copy of the GCP see <http://lutonlscb.org.uk/pdfs/gcp.pdf>
- Stein M. (2009) *Quality Matters in Children's Services: Messages from Research*, London, Jessica Kingsley.
- Taussig, H. N., Clyman, R.B., and Landsverk, J. (2001) Children who return home from foster care: a 6-year prospective study of behavioral health outcomes in adolescence, *Pediatrics*, 108, 1, 10.
- Thoburn, J. (1994) *Child Placement: Principles and Practice*, Suffolk, Arena.
- Thoburn J. (2009) *Reunification of children in out-of-home care to birth parents or relatives: A synthesis of the evidence on processes, practice and outcomes*, Munchen, Deutsches Jugendinstitut.
- Thoburn, J. (with Making Research Count Consortium) (2009a) *Effective interventions for complex families where there are concerns about or evidence of a child suffering significant harm*. London, Centre for Excellence and Outcomes in Children and Young People's Services (C4EO) http://www.c4eo.org.uk/themes/safeguarding/files/safeguarding_briefing_1.pdf.
- Thoburn, J. (2010) 'Towards knowledge-based practice in complex child protection cases: a research-based experts' briefing', *Journal of Children's Services*, Vol 5 Issue 1, pp. 924.
- Thoburn, J., Robinson, J. and Anderson, B. (2012) *SCIE Research briefing 42: Returning children home from public care*, Social Care Institute for Excellence. <http://www.scie.org.uk/publications/briefings/briefing42/>
- Thoburn, J., Chand, A. and Procter, J. (2005) *Child Welfare Services for Minority Ethnic Families: The Research Reviewed*, London, Jessica Kingsley.
- Thornberry, T., Henry, K., Ireland, T. and Smith, C. (2010) The Causal Impact of Childhood-limited Maltreatment and Adolescent Maltreatment on Early Adult Adjustment, *Journal of Adolescent Health*, 46 (4), pp. 359–365.
- Turney, D., Platt, D., Selwyn, J. and Farmer, E. (2011) *Improving Child and Family Assessment: Turning Research into Practice*, London, Jessica Kingsley.
- Wade, J., Biehal, N., Farrelly, N. and Sinclair, I. (2011) *Caring for Abused and Neglected Children: Making the Right Decisions for Reunification or Long-term Care*, London, Jessica Kingsley.
- Ward, H., Brown, R. and Westlake, D. (2012) *Safeguarding Babies and Very Young Children from Abuse and Neglect*, London, Jessica Kingsley. A summary of the study can be found at DFE-RB053. Their later study of these children aged 3 to 5 is Ward, H., Brown, R. and Maskell-Graham, D. (2012a) *Young Children Suffering, or Likely to Suffer Significant Harm: Experiences on Entering Education*, London, Department for Education.
- Ward, H., Brown, R. and Hyde-Dryden, G. (2014) *Assessing Parental Capacity to Change when Children are on the Edge of Care: an overview of current research evidence*, London, Department for Education.
- White, O. G., Hindley, N. and Jones, D. P. H (2015) 'Risk factors for child maltreatment recurrence: an updated systematic review', *Medicine, Science and the Law*, Vol. 55 (4), pp 259–277.
- The Who Cares? Trust (2006) *The Journey Home: How children's services can support the reunification of children with their families*, London, The Who Cares? Trust.

Annexes

Tables and templates

Annex 1: Definitions of risk & protective factors	72
Annex 2: Accessible version of Risk Classification Table for children and parents	79
Annex 3: Chronology template, top tips and case study	80
Annex 4: Basic genogram components	83
Annex 5: Return Home Assessment Report Template	85
Annex 6: Young Person's Report	91
Annex 7: Written Parental Agreements	93
Annex 8: Setting and Reviewing Goals	96
Annex 9: Reunification Plan Template	98

Additional guidance

Annex 10: Amended Care Planning Regulations and Guidance for Children Ceasing to be Looked After	99
Annex 11: Case eligibility and fit with court timescales	103
Annex 12: Tips for working with children and young people	104
Annex 13: Special considerations when assessing return home from care in relation to babies	106
Annex 14: Assessing risks and protective factors and planning for positive outcomes for adolescents in relation to return home from care	108
Annex 15: Case study showing the impact of the assessment for a young person who 'walked themselves home'	112
Annex 16: Engaging parents	113
Annex 17: Parents with learning disabilities	114
Annex 18: Top Tips for assessment	115
Annex 19: Assessing parental capacity to change	116
Annex 20: Neglect	120
Annex 21: Additional guidance for working with families where reunification will not be possible	121
Annex 22: Families who experience multiple removals of their children	122
Annex 23: Example of later life letter	123
Annex 24: Case supervision for the Practice Framework	125

Annex 1

Definitions of risk & protective factors

Source: Jones *et al* (2006) adapted by Rebecca Brown and Harriet Ward (see Ward, Brown and Westlake, 2012), further adapted by the NSPCC in 2015 to reflect White *et al* (2015)

Factors	Future significant harm more likely	Future significant harm less likely
Abuse	<p>Severe physical abuse including burns/ scalds</p> <p>Severe injury caused to child to warrant hospital admission/medical treatment. Examples include; broken bones, head injury. The terminology of 'rough handling' may mask the risks of physical injury or death (Brandon <i>et al</i>, 2009). See also section on defining maltreatment below.</p>	<p>Less severe forms of abuse</p> <p>Defined in terms of harm, duration and frequency. Physical abuse which does not warrant hospital admission/medical treatment. Note: If severe, yet parent shows compliance with child protection plan and does not deny abuse occurred or their part in it, success is still possible.</p>
	<p>Neglect</p> <p>See section on defining maltreatment in the table below.</p>	
	<p>Severe growth failure</p> <p>Stunted growth and failure to thrive without evidence of a medical reason. Examples include parents forgetting to feed an infant and thus causing failure to thrive.</p>	
	<p>Multiple types of maltreatment</p> <p>Evidence that more than one type of abuse is being experienced by child, including combinations of physical abuse, neglect and witnessing intimate partner violence. See also section on defining maltreatment below.</p>	
	<p>More than one affected child in household</p>	
	<p>Previous maltreatment</p> <p>If either or both parents (if have some responsibility in caring for child) have previously had a child permanently removed, or a child who has been subject to a child protection plan.</p>	
	<p>Sexual abuse with penetration or a long duration</p> <p>Sexual abuse or sexual grooming that the child's primary caregiver(s) were responsible for or compliant with. See also section on defining maltreatment below.</p>	
	<p>Fabricated/induced illness</p> <p>Evidence from a medical practitioner that the child has been subject to a fabricated or induced illness and that their primary caregiver(s) had been responsible or compliant.</p>	

Factors	Future significant harm more likely	Future significant harm less likely
Abuse (cont)	Sadistic abuse Child cruelty: child treated in an inhumane and degrading manner.	
Child	Development delay with special needs Both developmental delay caused by a disability/illness and/or development delay attributed to poor parenting should be included. There would need to be evidence from a medical/health/educational professional that developmental delay is an issue. Special needs attributed to a disability/illness and/or attributed to emotional and behavioural difficulties should be included.	Healthy child A healthy child who does not have any of the following: illness/disability, development delay, special needs, emotional or behavioural difficulties. Note: There may be difficulties with this category for very young children and babies as it may be too early to know whether there are any health or developmental problems. If there is no evidence, then this category should not be included. It should not be assumed that the child is healthy.
		Attributions (eg not blaming self in sexual abuse) Not applicable for infants in first year of life.
	Child's mental health problems Diagnosed mental illness for which medical/therapeutic intervention is necessary. For a baby or very young child this category should not be included.	
	Very young child requiring rapid parental change.	Later age of onset Not applicable for infants in first year of life.
		One good corrective relationship Not applicable for infants in first year of life.
Parent	Personality disorder (anti-social, sadistic, aggressive) Diagnosed personality disorder for which medical/therapeutic treatment is necessary for primary carer(s) of child. Paranoid psychosis Diagnosed paranoid psychosis should be included. A parent stating that they sometimes feel paranoid, and without diagnosis should not. Significant Parental Mental Health Problems	Mental disorder responsive to treatment The primary caregiver should be accessing and responding to the treatment been given for their mental disorder.
	Learning disabilities when plus mental illness Learning disability and mental illness together, and mental illness alone. Mental illness should be diagnosed by a mental health professional or GP. A parent or non-health professional stating that for instance, 'they can feel depressed' should not count. Note: Mental illness alone should be classified as a risk factor; however, learning disabilities alone should not be, unless it comes with mental illness.	

Factors	Future significant harm more likely	Future significant harm less likely
Parent (cont)		Non-abusive partner A partner for whom there are no current concerns of abuse either to children or to their partner. This is especially relevant if one parent has a history of abuse, and the other does not, and can be either the father or mother, or stepfather or stepmother. This might also include a partner for whom there have been past concerns that have since been entirely overcome.
	Lack of compliance Hostility towards professionals, deliberate deception, sporadic engagement, not giving professionals access to children, and numerous cancelled appointments with social workers without justified reason. False compliance should be included – i.e., telling social workers what parents think they want to hear, rather than working with social workers.	Willingness to engage with services The primary caregiver(s) should be willing to accept social care and other service involvement with their family as a necessary measure to safeguard their children. Appointments should be kept and not cancelled without good reason. Primary caregivers should also be willing to participate with other relevant services. Children’s attendance at school/nursery should not be a cause for concern, and children should be taken to all their necessary health appointments which should not be cancelled without good reason.
	Denial of problem Parents’ inability to acknowledge their destructive behaviour, or deny the part their own actions have had in the abuse of this child or previous children. For example: can a parent understand why a child witnessing intimate partner violence is harmful, or how their own drug use might affect their ability to care for their child and meet their physical and emotional needs?	Recognition of problem Parents should be able to acknowledge why their behaviour is affecting or has affected their ability to care for their child and meet their emotional and physical needs.
		Responsibility taken Primary caregiver(s) should be making some steps in taking responsibility for their actions, i.e., they should not blame others for their own destructive behaviour.
	Substance abuse An addiction to substances such as class A drugs, class B drugs, alcohol or any other substance that impairs the child’s primary caregiver(s’) ability to make sound judgements and to meet their physical and emotional needs. A parent on a methadone, or other similar, programme should be included. Primary caregiver(s) who do not themselves take drugs, but allow the child’s home to be used for drug taking and/or who routinely leave children unsupervised with a non-primary caregiver who is under the influence of drugs and/or is drunk should also be included.	

Factors	Future significant harm more likely	Future significant harm less likely
Parent (cont)	<p>Abuse in childhood – not recognised as a problem</p> <p>Any type of childhood abuse should be included. Evidence can be taken from case file papers, assessments and the parents’ own accounts.</p> <p>Note: Evidence that a parent does or does not view their own experiences of childhood abuse as a problem can be difficult to ascertain. If there is evidence that a parent experienced childhood abuse but not whether they recognise it as problem it should be included.</p>	<p>Adaptation to childhood abuse</p> <p>Primary caregivers who have received therapeutic intervention to help them come to terms with childhood abuse should be included, unless it is clear that the caregiver has not been able to adapt to their earlier experiences. Primary caregivers who experienced childhood abuse and can focus on the needs of their own children should be included.</p>
	<p>History of Violence or Sexual Assault</p>	
Parenting and parent/child interaction	<p>Disorganised attachment; severe insecure patterns of attachment</p> <p>Observed by a health/childcare professional. This information is difficult to ascertain from social care case files, as limited information on the child’s development and emotional and psychological needs is recorded and what there is may not be based on a clinical understanding of attachment disorders.</p>	<p>Secure attachment; less insecure attachment patterns</p> <p>Observed by a health/childcare professional. This information is difficult to ascertain from social care case files, as limited information on the child’s development and emotional and psychological needs is recorded and what there is may not be based on a clinical understanding of attachment.</p> <p>Note: If attachment is not observed/recorded to be either disordered or normal this category should not be included. It should not be assumed that there is a normal attachment, if an attachment disorder is not recorded/observed.</p>
	<p>Lack of empathy for child</p> <p>The parent(s) do not show understanding of how the child might experience adverse situations, such as how a child might feel if their parents are fighting, or how a neglected child might feel if their needs are not being met. This would also include the child being treated in a degrading or inhumane way.</p>	<p>Empathy for child</p> <p>Understanding of how the child might feel in adverse situations, and/or if their needs were not being met.</p>
	<p>Poor parenting competence</p> <p>Lack of competence in everyday tasks needed for childrearing. This might include some of the following: establishing routines, feeding, bathing and clothing a child, upkeep of a household, paying bills, and going shopping. Inability to help with homework, or to get the child to and from school on time (or at all). This can also include: not showing emotional warmth and affection, and not providing the child with a nurturing environment.</p>	<p>Parenting competence in some areas</p>
	<p>Own needs before child’s</p> <p>The parent(s) prioritising their own needs. For example, a parent remaining in an abusive relationship to the detriment of the child; a parent appearing more attached to drugs or alcohol than to the child.</p>	
	<p>Parent-child relationship difficulties</p>	

Factors	Future significant harm more likely	Future significant harm less likely
Family	<p>Inter-parental conflict and violence</p> <p>Physical and emotional violence between the child's caregivers, or one caregiver and another adult taking place within the child's home.</p>	<p>Absence of domestic abuse</p> <p>This would include both families where domestic violence has been a concern in the past but it is not a current concern, and families where it has never been a concern.</p>
	<p>High stress</p> <p>Examples of family stress include: housing problems including homelessness and inadequate housing, financial difficulties, conflict within the extended family, conflict within the neighbourhood, family crisis such as bereavement or relationship breakdown.</p>	<p>Non-abusive partner</p> <p>Supportive extended family</p> <p>Extended family able to provide emotional and practical support for the caregivers and children. It is important that the caregivers view this as beneficial.</p>
	<p>Power problems: poor negotiation, autonomy and affect expression</p> <p>Poor self regulation, lack of congruence, unable to manage emotions pertinent to the situation.</p>	<p>Capacity to change</p> <p>This should be demonstrated with evidence. A parent stating their desire to change is not sufficient. For example, there should be clear evidence that substance misuse has stopped, or clear evidence that an abusive partner has left the household and has no further contact.</p>
	<p>Children not visible to outside world and continuing perpetrator access</p>	
Professional	<p>Lack of resources</p> <p>Resources not available, resources not offered when available, resources available but not accessible.</p> <p>No professional or therapeutic relationships with child or family.</p>	<p>Resources available</p> <p>Resources available, appropriate and accessible.</p> <p>Good professional relationships with family, therapeutic relationship with child.</p>
	<p>Poorly skilled professionals</p> <p>Definition: child not seen, multiple changes of worker, cases unallocated, lack of professional boundaries, poor practice, professionals do not share information/lack transparency with child or family, over-optimism.</p>	<p>Partnership with parents</p> <p>Definition: effective working relationship between parents and social workers based on honesty and trust.</p>
		Outreach to family
		Therapeutic relationship with child
Social setting	<p>Social isolation</p> <p>Parents who have little or no contact with others on a social basis. They may stay home most days with little or no contact with their community.</p>	<p>Social support</p> <p>Parents are able to access community resources and support on a voluntary basis.</p>
	<p>Lack of social and family support networks and lone parenthood</p> <p>Parents who have little positive contact within their community, and no access to (or no engagement with) community resources.</p>	<p>More local child care facilities</p> <p>Preponderance of facilities in their area such as children's centres and community groups etc. Parents should be engaging with these services to be included in this category.</p>
	<p>Violent, unsupportive neighbourhood</p> <p>These neighbourhoods include those where drug taking and crime are rife.</p>	<p>Volunteer network</p> <p>Positive community resources and environment.</p>
		Involvement of legal or medical services

Defining maltreatment

The following definitions of maltreatment have been taken from *Working Together to Safeguard Children: A guide to inter-agency working to safeguard and promote welfare for children* (HM Government, 2015).

Abuse: A form of maltreatment of a child. Somebody may abuse or neglect a child by inflicting harm, or by failing to act to prevent harm. Children may be abused in a family or in an institutional or community setting by those known to them or, more rarely, by others (e.g. via the internet). They may be abused by an adult or adults, or another child or children.

Physical abuse	A form of abuse which may involve hitting, shaking, throwing, poisoning, burning or scalding, drowning, suffocating or otherwise causing physical harm to a child. Physical harm may also be caused when a parent or carer fabricates the symptoms of, or deliberately induces, illness in a child.
Emotional abuse	The persistent emotional maltreatment of a child such as to cause severe and persistent adverse effects on the child's emotional development. It may involve conveying to a child that they are worthless or unloved, inadequate, or valued only insofar as they meet the needs of another person. It may include not giving the child opportunities to express their views, deliberately silencing them or 'making fun' of what they say or how they communicate. It may feature age or developmentally inappropriate expectations being imposed on children. These may include interactions that are beyond a child's developmental capability, as well as overprotection and limitation of exploration and learning, or preventing the child participating in normal social interaction. It may involve seeing or hearing the ill-treatment of another. It may involve serious bullying (including cyber bullying), causing children frequently to feel frightened or in danger, or the exploitation or corruption of children. Some level of emotional abuse is involved in all types of maltreatment of a child, though it may occur alone.
Sexual abuse	Involves forcing or enticing a child or young person to take part in sexual activities, not necessarily involving a high level of violence, whether or not the child is aware of what is happening. The activities may involve physical contact, including assault by penetration (for example, rape or oral sex) or non-penetrative acts such as masturbation, kissing, rubbing and touching outside of clothing. They may also include non-contact activities, such as involving children in looking at, or in the production of, sexual images, watching sexual activities, encouraging children to behave in sexually inappropriate ways, or grooming a child in preparation for abuse (including via the internet). Sexual abuse is not solely perpetrated by adult males. Women can also commit acts of sexual abuse, as can other children.
Neglect	The persistent failure to meet a child's basic physical and/or psychological needs, likely to result in the serious impairment of the child's health or development. Neglect may occur during pregnancy as a result of maternal substance abuse. Once a child is born, neglect may involve a parent or carer failing to: <ul style="list-style-type: none"> • provide adequate food, clothing and shelter (including exclusion from home or abandonment); • protect a child from physical and emotional harm or danger; • ensure adequate supervision (including the use of inadequate care-givers); or • ensure access to appropriate medical care or treatment. It may also include neglect of, or unresponsiveness to, a child's basic emotional needs.

Examples of maltreatment have been defined in the following way:

Event/situation	Type of maltreatment
Physical assault	Physical abuse
<i>In utero</i> intimate partner violence	Physical abuse
Witness to intimate partner violence	Emotional abuse
Threats of abandonment	Emotional abuse
Presence in household of convicted paedophile	Risk of sexual abuse
Left alone	Neglect
<i>In utero</i> drugs	Neglect
Instability (frequent changes of primary carer and/or domicile)	Neglect
Drug use in household	Neglect
Unkempt	Neglect
Unsafe situations	Neglect
Chaotic lifestyle of parent	Neglect
Not meeting health needs	Neglect

Annex 2

Accessible version of Risk Classification Table for children and parents

Low risk	Medium risk	High risk	Severe risk
Previous risks gone. Any other risks are low.	Some risks	Lots of risks	Lots of risks
Lots of protection	Lots of protection	Some protection	No protection
Parents have made lots of changes	Parents have made lots of changes	Parents have not made any changes	Parents have not made any changes
Child and parents want return home to happen	Child and parents want return home to happen	Child or parents may not want return home to happen	Child or parents may not want return home to happen
It will be safe to go home	It will be safe to go home with some support	It will not be safe to go home	It will not be safe to go home

Annex 3

Chronology template, top tips and case study

This Annex contains a template table and top tips to support workers to gather, record and analyse the family's history. Workers will use this information to produce an analysis of the risk and protective factors, key themes and parental capacity for change which will be written up for the Return Home Assessment

Report (or existing local report templates can be used).

The case study highlights the importance of workers having a full understanding of the child's history.

Case History Template

Date and child's age at time of event	Event	Potential or actual impact on child	Risk or protective factor	Evidenced by/in	Comments: To be completed during analysis
23.05.10 Child A aged 5	Police attend family home where Ms R has been assaulted by her partner Mr E. Child A at home	Emotional impact on child of witnessing D/V Potential for physical abuse	Risk factor D/V	Police notification to children's services	7 police calls to home in 6 months between 02.05.10 and 08.12.10
02.08.10	Ms R attends GP surgery to book for ante natal care. Estimates she is 6 months pregnant	Potential impact on unborn child of assault in May. Lack of ante natal care may impact on child	Risk factor	Health visitor's report to child protection case conference on Child A	
14.08.10	Ms R tests free from drugs in past 28 days		Protective factor	Community addictions report to children's services	3rd clear drugs test – coincides with regular attendance at counselling
25 .08.10	Mr E arrested for possession of cannabis after stop & search in street		Risk	Police report	
14.09.10	Mr E attends assessment for domestic violence group programme		Potential protective factor	Letter from Group work Coordinator to social worker. Case File record 5114	

Tips for producing an analytical case history

Remember the purpose

The purpose of the case history is to consider the risk and protective factors associated with the child returning home and the support and services that will be needed if return home is to be safe and stable. The history is key to equipping the worker to make judgements about the parents' level of honesty and understanding of professional concerns. Understanding the case history will help the social worker to tailor their assessment sessions around the most pertinent issues.

The case study below illustrates the difference that an understanding of the history made to the decision whether or not a child should return home.

Conduct a comprehensive file read

It is important that all available information is read to ensure that no key details are missed. The worker should ask questions where information is missing – other agencies may hold those details or the absence of information may be telling in itself. The worker should read the files and analyse the information first before deciding which information will be presented in the table and in the assessment report.

Using the Chronology Template

- Be succinct
- Provide a key to all abbreviations
- Be consistent in the use of terms
- Be clear about the source. Where was the information found, who provided the information and their profession/role
- Record when events actually happened (not only when they were recorded)
- Distinguish between fact, opinion and hearsay.

Writing the analysis for the assessment report

The worker should highlight risk and protective factors, pull out themes and patterns in the history, identify evidence of capacity to change and consider quality/reliability of the evidence. Hindsight may suggest a need to challenge the analysis provided at the time of a recorded incident – the worker should include the new analysis and explain why they have reached this conclusion.

Balance

Risk *and* protective factors and evidence of improvements and deterioration need to be included in the analysis. The Factors Associated with Future Harm table (see p.25) is helpful in understanding and interpreting how these factors might impact on parenting and the child's experiences. A balanced view will enable a thorough and fair assessment which can consider all the options for meeting the best interests of the child.

Case study illustrating the impact of a good case history on a return home from care decision

The case concerns five siblings who were subject to Interim Care Orders. An extension was made to care proceedings in order for the **Return Home from Care Assessment** to take place due to previous assessments being inconclusive. The children came into care due to ingesting medication resulting in them requiring admission to intensive care.

Throughout the course of the assessment the **parents maintained that the children were removed from their care due to a one off accident**, and that they had now ensured that all medication was locked away. However the worker completing the case history carefully considered family's files which found that there were **systemic, long standing concerns in relation to neglect throughout the immediate and wider family**. The following was found:

- **10 initial assessments** had been completed on the family by social care, where each referral had been considered **in isolation without a thorough analysis and understanding of the history** ever being completed.
- The eldest children displayed **challenging behaviour** at home and in school which could be attributed to the parenting they had received.
- There were long standing concerns in relation to **extremely poor home conditions**. When social workers had visited, parents had made improvements. However, these were **never sustained**.
- Some of the **children displayed sexualised behaviours**. The case history showed that there were **known persons**

posing risk in the wider family and the children had been exposed to these individuals.

- There was **domestic violence in the parents' relationship**.
- Father had a long history of **substance misuse and offending behaviour**. There was also evidence that **the eldest child had been involved in this offending behaviour** as a look out.
- Parents were unable to **engage consistently with professionals** and attend appointments. For example the children had poor school attendance, parents had **failed to engage in parenting work** with the health visitor or with other medical staff, and father had **not accessed substance misuse services as he reported he had**.

The conclusion of this work was that the incident that had resulted in the children coming into care was in fact an 'accident waiting to happen' and **culmination of long standing neglect and poor supervision**. When the social worker challenged the family with the detail of the history they disputed it as all lies and could show **no insight or take any responsibility for the children's experiences**. As a result a risk classification of severe was concluded and the children were made subject to full Care Orders with the youngest being made subject to Placement Order. **The judge, the children's guardian and the team manager praised the case history as this evidence was key to reaching a conclusion and helped make the right decision for these children.**

Annex 4

Basic genogram components

Source: Kathleen M. Galvin <http://facultyweb.at.northwestern.edu/commstud/galvin/Genograms/>

The male is noted by a square, the female by a circle. The male is placed to the left of the female in the father/mother dyad. Marriage is shown by a line connecting the two.



Children are noted oldest to youngest, left to right. The index person of the genogram (or person from whose perspective it is being drawn) is set off from the others and marked with double lines. Birth dates are often recorded to the upper left or right. If the first two digits of the year can't be mistaken, the last two digits of the year are often all that's needed.

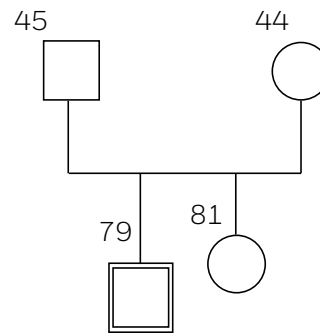

Other importation notations are shown below:

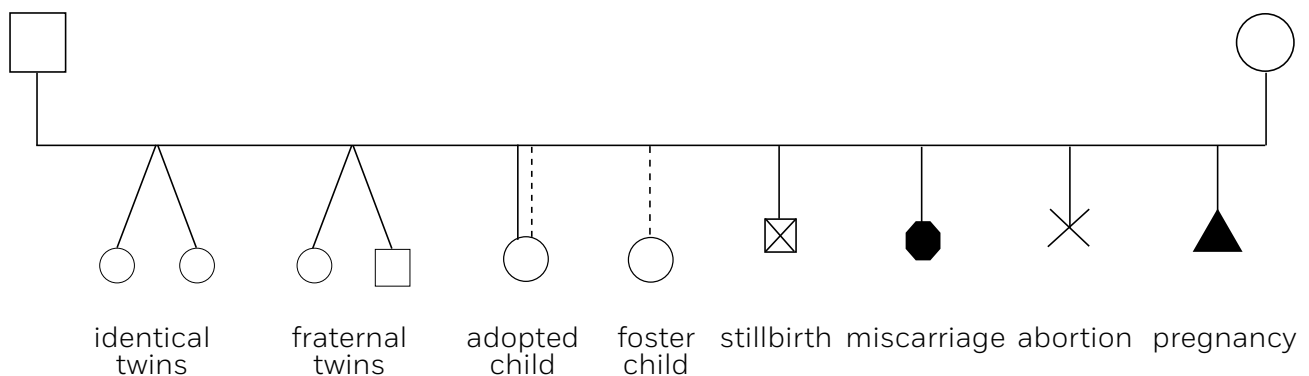

Liasons or a couple living together are displayed similar to marriage, but with a dotted line.



Marriage dates are recorded above the line connecting husband and wife.

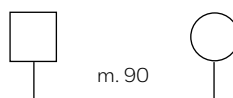

A **separation** of a couple is marked with one slashed line. The date is also usually recorded.

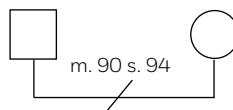

A **divorce** of a couple is marked with two slashed lines. The date is also usually recorded.

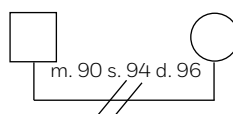

The **death** of a person is indicated by an 'x' through the shape. The birth and death dates are also usually recorded.



A **remarriage** (or former marriage) is shown to the side with a smaller shape. The focus couple is the one in the middle with the larger shapes. *Note: If there has been more than one remarriage, the marriages are usually placed from left to right with the most recent marriage coming last.*

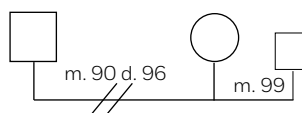

Annex 5

Return Home Assessment Report Template

Workers will write up and share their assessment as part of the care planning process. This template suggests questions that need to be addressed as part of the decision-making around reunification.

Workers may use this template, or integrate the questions into existing local forms / templates.

Return Home Assessment Report in Respect of ... DOB ...

Contents

1. Introduction:
 - 1.1 Introduction and purpose of report
 - 1.2 Roles and responsibilities
 - 1.3 Assessment process
 - 1.4 Additional information
2. Findings:
 - 2.1 Summary of data
 - 2.2 Analysing data and classification of risk for reunification
 - 2.3 Decision-making, planning and monitoring
3. Appendices:
 - 3.1 Appendix 1 – Risk Classification Tool
 - 3.2 Appendix 2 – Definitions of risk and protective factors
 - 3.3 Appendix 3 – Genogram
 - 3.4 Appendix 4 – Chronology

1. Introduction

1.1 Introduction and purpose of report

XXX Children's Services have undertaken this assessment using the Reunification Practice Framework. This report has been written by the assessment team and the conclusion and recommendations agreed together.

The assessment uses an evidence-informed framework for analysing and classifying the risk of re-abuse or continuing maltreatment to inform decision-making with regard to reunification. The Framework seeks to ensure that children and young people's best interests are central to all decision-making. Children should only be returned home when the classification is considered to be 'Low Risk' or 'Medium Risk'. Where the classification is 'High Risk', concurrent planning for possible permanent separation may be desirable, especially with young children. Where the classification is 'Severe Risk', reunification should not be considered.

This assessment does not serve the interest of the local authority or the parent but rather the child, [name ...], and his or her best interests and his or her right to have a safe, nurturing environment in which to develop.

1.2 Roles and responsibilities

Independent review of information available, i.e., Children's Services file/records and a genogram and chronology developed. No direct contact with the child or any member of the child's family.

This was undertaken by [add in names of social worker and any other staff involved] (Appendix 2 – Genogram; Appendix 3 – Chronology).

Obtaining the child's wishes and feelings/assessment of the child with regards to reunification.

Gathering of existing data on risk and protective factors and assessing parental capacity to change.

This was undertaken by ... the children's social worker.

1.3 Assessment process

The Reunification Practice Framework requires the assessment of the parent(s)' capacity to change and their ability to sustain that change over time as this is a critical part of decision-making and planning for reunification.

This assessment is also informed by the information gathered in the chronology and genogram.

The assessment of ... parent's, ... parental capacity for change is based upon the following:

- One introductory meeting on, ... held at their home address. Between ...
- Assessment sessions undertaken by ... with ... on ... Each of these sessions lasted between 1-2 hours. These sessions were undertaken in the family home.
- Discussion between ... and ... (Independent Reviewing Officer)
- Discussion between ... and ... (any other professionals)
- Case meetings between the professionals involved on ...
- Information gathered through the file read completed by ...

The Practice Framework also requires an assessment of the child, their attachments and their wishes and feelings in respect of reunification as this is a critical part of decision making and planning for reunification.

The assessment of ... is based upon the following:

- Assessment sessions undertaken by ... with ... on ... Each of these sessions lasted between 1–2 hours.
- Observations of contact between ... and ..., by ... on ...

1.4 Additional information

2. Findings

2.1 Section One: Summary of data

Summary of significant events, and/or reason for entry to care/accommodation. Including reference to parental alcohol/drug misuse, domestic violence, and mental ill health. View on who was responsible for abuse or neglect.

Summary of any significant events since entry to care/accommodation.

Summary of previous services and their impact.

Family composition before entry to care/accommodation and currently, commenting on child's attachments. Are there any changes to family composition and are these likely to be positive or negative for the child?

Please see genogram attached in appendix 2 for family composition.

Risk factors identified for each individual child on entry to care/accommodation. Highlight any that should be given extra weight.

Risk factors identified for each individual child when considering reunification. Highlight any that should be given extra weight.

Protective factors identified for each individual child on entry to care/accommodation. Highlight any that should be given extra weight.

Protective factors identified for each individual child when considering reunification. Highlight any that should be given extra weight.

Evidence of parental capacity to change and views on capacity to change in time to meet child's needs.

- **Attendance, attitude and motivation in relation to taking part in the assessment**
- **Whether the problems that initially resulted in the child coming into care/ accommodation are acknowledged and are being addressed**
and
- **Whether the parents/carers acknowledge and are ready and able to address any remaining or new risk factors**
- **Whether they are likely to be able to make the necessary changes within the child's timescale taking account of the child's age and developmental needs**

Child's views and motivation in relation to reunification (and views on any previous failed reunifications).

Factors associated with each individual child/young person's attributes and experiences, with particular consideration of risk and protective factors.

- **Age at which child/young person became Looked After.**
- **Length of time the child/young person has been Looked After and number of placements.**
- **Previous attempts at return to birth parent/s – why did these not meet the needs of the child/young person.**
- **Child's strengths (*considering health, education, emotional and behavioural development, identity, family and social relationships, social presentation and self-care skills*).**
- **Child's vulnerabilities (*considering health, education, emotional and behavioural development, identity, family and social relationships, social presentation and self-care skills*).**
- **The child/young person's level of attachment to the birth parent/s.**
- **Regularity and quality of contact between birth parents and child/young person whilst Looked After.**
- **The child/young person's relationship with and attachment to the current caregivers.**
- **View/feelings of significant adults, including current caregivers and schools, about the child/young person returning to the care of their birth parent/s.**

Each individual child/young person's expressed wishes and feelings.

- **The child/young person's understanding of why they are Looked After.**
- **The child/young person's awareness of changes that have taken place in the birth family whilst in care/accommodation.**
- **The child/young person's understanding of what life would be like should they return home.**
- **Which relationships are important to the child/young person.**
- **Child's view of parent's new partner (if applicable)**
- **What does the child/young person feel needs to change in order for them to return home.**
- **The child/young person's view of whether they should return home.**

(Please attach copies of any tools used to obtain views, e.g. Three Islands, Three Houses)

Professional analysis of each individual child/young person's best interests in relation to reunification, balancing individual attributes, experiences and expressed wishes and feelings.

Parents' views and motivation in relation to reunification (and views on any previous failed reunifications).

2.2 Section Two: Analysing data and classification of risk for reunification

Summary of the analysis of risk and protective factors for each individual child.

Summary of changes that would need to be made for reunification to occur and indication of timescales.

Child's views on the analysis of data and reunification.

Parents' views on the analysis of data and reunification.

Placement caregivers' views on the analysis of data and reunification (if appropriate).

Classification of risk for reunification of each child: **Severe/High/Medium/Low**

2.3 Section Three: Decision-making, planning and monitoring

Decision on reunification (including legal or protective actions required).

If reunification is not possible:

Summary of the next steps.

If reunification is possible:

ADD IN PARENTAL AGREEMENTS AND REUNIFICATION PLAN

What do parents need to achieve to enable reunification (these need to be SMART goals – Specific, Measurable, Agreed with families, Realistic and Time-Bound).

What services, interventions or support are required to facilitate reunification?

What are the timescales for goals to have been achieved?

What are the consequences if goals are not achieved?

How will progress in achieving the goals be monitored?
By whom? How often?

Signatures:

Please note:

The Care Planning and Fostering Regulations 2015 state that a decision that a child who has been a looked after child for at least 20 working days will cease to be looked after must be approved by a nominated officer. Where the child is 16 or 17 and is not in the care of the local authority, the decision to cease to look after them must not be put into effect until it has been approved by the responsible authority's director of children's services.

.....
Nominated Officer / Director of Children's Services

.....
Children's Services

.....
Children's Services

.....
Team Manager,

.....
Other Manager and/or IRO

Annex 6

Young Person's Report

Return Home Assessment

Young Persons report in Respect of ...

Date of birth: ...

Introduction

On the (date) your social worker ... spoke to you to help make a decision about whether you could return home to ...

At this time you were living with in (foster care/residential care). You were having contact with your (mum/ dad/ parents) ... and you/your parents said they would like to be assessed to see if it was safe for you go home.

It was agreed we would use a new kind of assessment to help make the decision. We did the following:

- Looked at you and your family's history, for example why you came into care and what support your family were offered.
- Assessed your mum and dad
- Looked at how risky it would be for you to return home and to help make plans for your future. We used this model to help make the decision:

Low risk	Medium risk	High risk	Severe risk
Previous risks gone. Any other risks are low	Some risks	Lots of risks	Lots of risks
Lots of protection	Lots of protection	Some protection	No protection
Parents have made lots of changes	Parents have made lots of changes	Parents have not made any changes	Parents have not made any changes
Child and parents want return home to happen	Child and parents want return home to happen	Child or parents may not want return home to happen	Child or parents may not want return home to happen
It will be safe to go home	It will be safe to go home with some support	It will not be safe to go home	It will not be safe to go home

Decision

Decision on risk:

In the end it was decided that it was, e.g.:

Low risk
Previous risks gone. Any other risks are low
Lots of protection
Parents have made lots of changes
Child and parents want return home to happen
It will be safe to go home

Summary of the next steps.

As it was decided that it was safe for you to go home, plans need to be put in place to help you and your parents in this process. Therefore we are working with ... and have made a plan for you and your parents to help this happen. It's really important your views are included in this plan, so please tell us if we have missed anything.

(Attach plan)

[OR

As it was decided that it would not be safe to go home to ... plans needed to be made to make sure you had the best opportunity to be well cared for all of your childhood. Therefore we decided/the court decided that you should live ...]

Any questions?

If you have any questions about this report please talk to whoever is sharing this with you.

It may be that in the future you want to read the full report that helped to make this decision and if so you can request to see your records.

Annex 7

Written Parental Agreements

Developed with Rebecca Brown, Loughborough University. Adapted by NSPCC for the reunification of looked after children. This agreement can be adapted and integrated with your existing local templates.

Parental Agreement Between

[Insert name of parent(s) & name of worker(s)/local authority team]

Name of child:

DOB:

Date of risk classification decision:⁹²

Identified level of risk to child/ren if returned home:

(please circle)

Low

Medium

High

Today's date:

Date of next review:

This is an agreement between [**NAME OF PARENT(S)**] and [**NAME OF AUTHORITY**] to help [**NAME OF PARENT(S)**] to understand what the concerns are, what is expected of them, and what they need to change in order for their child, [**NAME OF CHILD**], to be returned home. This agreement allows [**NAME OF PARENT(S)**] to see how they are progressing, including through the use of a 'traffic light' chart. [**NAME OF PARENT(S)**] will be provided with support and services which will build on their strengths in order to protect their child/ren. This agreement will be reviewed at regular intervals.

1. [**INSERT PARENT(S) NAME**]'S STRENGTHS (Specify the protective factors which improve the chances of reunification)

⁹² In some cases, social workers will use parental agreements during the assessment, before the risk will have been classified.

2. **CONCERNS THAT MAY PREVENT [CHILD] RETURNING TO HOME (Risk factors that place [child] at risk of harm)**

3. **GOALS THAT PARENT/S NEED TO ACHIEVE BY NEXT REVIEW DATE**

Overarching goals

1.

2.

3.

Steps needed to achieve each goal

Goal 1:

a.

b.

c.

d.

(etc)

4. **EXPECTED OUTCOMES OF GOALS**

[You can use staged goals and/or expected outcome of goals -see Annex 8 on Goals]

5. **WHAT SUPPORT AND SERVICES WILL BE PROVIDED TO HELP PARENT(S) TO ACHIEVE GOALS** (link with reunification plans in Stage 4)

1.

2.

3.

6. IF GOALS ARE NOT REACHED BY THE NEXT REVIEW THE FOLLOWING WILL HAPPEN:

7. REVIEW OF PROGRESS MADE TOWARDS THESE AGREED GOALS

Date of Review:

8. GOALS THAT PARENT/S NEED TO ACHIEVE BY NEXT REVIEW DATE

Overarching Goals

Steps needed to achieve goals

Expected level of outcome

I/we* [INSERT NAME] understand what is expected of me/us* to change and to show that my/our* child [NAME OF CHILD] can be returned to my/our* care. I/we* understand what will happen if I/we* do not reach the goals and do not show that I/we* can change and this change can continue. [worker to delete words as required*]**

Signed..... (parent) Signed.....(parent)

Signed..... (worker/practitioner)

Annex 8

Setting and Reviewing Goals

Example 1: Setting Staged Goals⁹³

Overarching goal:

For Sarah to improve the quality of food that Cayden will receive when he returns home. This means that Sarah will provide a balanced diet for Cayden.

What needs to change?

Prior to going into care there were professional concerns about Cayden receiving poor quality and quantity of food – he was routinely over fed with high fat and starchy food.

Goal 1:

Sarah to improve her knowledge and skills in relation to nutrition. Improvements will be measured every month and the goal will be reviewed in 3 months on [worker to insert date].

Aims:

- Sarah will understand why too much high fat and starchy food is not good for her child.
- Sarah will know what a balanced diet should contain.
- Sarah will know what foods to buy / have in stock
- Sarah will know how to prepare some meals

Sarah and [insert name of worker] will work together to achieve these aims.

Measuring the goals:

The worker can test Sarah's retention of the knowledge and skills by:

- Asking Sarah to develop a small number of menus for breakfast, lunch and dinner
- Seeing the shopping that Sarah has bought
- Seeing Sarah prepare some balanced meals that Cayden would enjoy.
- Asking her what she will be providing for Cayden's first week at home.

⁹³ Based on the Graded Care Profile (which is an assessment tool to measure the quality of care being given to a child) and SafeCare (which is an evidence-based home visiting programme that has been shown to reduce child maltreatment).

Example 2: Defining and grading expected achievement of goals

An overall objective may be that a parent (Jane) reduces her drinking. However, this goal is too big and unstructured for parents to achieve or demonstrate. Reduction in drinking needs to be specified as to what exactly is expected in terms of drinking and not drinking and over what period. The small steps that are specified can then be measured.

The following table is adapted from an example from Barlow, J. (2012) [Presentation at Home or Away: Making difficult decisions in the child protection system Partnership Conference, 22 February].

Goal agreed between parent and social worker and expected outcomes defined

	Goal 1 Jane reduces her drinking
Date goals set	17th March 2014
Review Date	17th May 2014
Much more than expected	<i>Jane does not drink alcohol at all. She attends and engages in all treatment appointments. She attends all contact sessions and plays attentively with Mikey.</i>
More than expected	<i>Jane has drunk once or twice. She attends and engages in all treatment appointments. She attends all contact sessions and plays attentively with Mikey.</i>
Most likely outcome	<i>Jane sometimes drinks at night. She is sober during the day, and attends all appointments and contact sessions, where she plays attentively with Mikey.</i>
Less than expected	<i>Jane is still drinking during the day and has missed some appointments. She arrived at a contact session hung over and grumpy and was not able to play with Mikey.</i>
Much less than expected	<i>Jane is drunk most of the time. She misses most appointments, and is not attentive to Mikey when she does attend contact. She has run out of money.</i>

Review of progress made: review date May 17th 2014

	Level of outcome achieved	Analysis
Goal 1 Jane reduces her drinking	<i>More than expected</i> Jane admitted to drinking twice since the goals were set in March. She has fully engaged in treatment. She attends all contact sessions and plays attentively with Mikey.	Drinking episodes were triggered by stress, but were limited to two evenings where Jane drank far less than previously. On both occasions she contacted her alcohol support worker the following day. Jane's presentation at contact has been positive and she has played attentively with Mikey. Positive feedback from foster carer.

Annex 9

Reunification Plan Template

Existing Care Plan, Child in Need or Child Protection Plans can be used, adding these additional fields as necessary.

The Reunification Plan should be directly linked to the Written Parental Agreements and the Assessment Report.

To be used as a guide only. If more than one child in the family is being considered for reunification additional information relevant to each individual child will need to be included.

This is a multi-agency agreement between the following agencies:

(List agencies here and person responsible for this plan in each agency)

.....
.....
.....

The timescale for reunification to occur (refer to timeframes linked to SMART goals in Parental Agreements). Consider school timetable

The type, nature and frequency of any preparatory work that needs to be undertaken prior to reunification, including contact between child and family and who will undertake it

The role of foster carers, residential staff and kinship carers in providing support pre and post reunification

The composition of the 'team around the child and the family' (including role of the child's school) and the services to be provided

Who will be the trusted adult for the child?

Schedule for increased contact, including first nights home and who will support and monitor

The type, nature and frequency of support work for children and parents post reunification

Frequency and nature of monitoring post reunification – by whom?

Detail of visiting schedule

The process by which any concerns or referrals will be collected and acted on post reunification

Process and dates for review

Details of the contingency plan if reunification fails

Annex 10

Amended Care Planning Regulations and Guidance for Children Ceasing to be Looked After

In April 2015, the government laid new Regulations and Guidance to strengthen the requirements to **assess and support** children and families in relation to children ceasing to be looked after, **including those returning home from care**. The NSPCC / University of Bristol Practice Framework is designed to support local authorities to fulfill these duties. We have extracted some of the key points from the regulations and guidance. Please note that to be fully informed, you will need to read the Regulations, Guidance and Working Together.

1. The Care Planning and Fostering (Miscellaneous Amendments) (England) Regulations 2015

Regulation 39 “Arrangements to be made when the responsible authority is considering ceasing to look after C” now reads as follows:

- (1) This regulation applies where the responsible authority are considering ceasing to look after C.
- (2) Before deciding to cease to look after C the responsible authority must—
 - (a) carry out an assessment of the suitability of the proposed arrangements for C’s accommodation and maintenance when C ceases to be looked after by them,
 - (b) carry out an assessment of the services and support that C and, where applicable P, might need when the responsible authority ceases to look after C,
 - (c) ensure that C’s wishes and feelings have been ascertained and given due consideration, and
 - (d) consider whether, in all the circumstances and taking into account any services or support the responsible authority intend to provide, that ceasing to look after C will safeguard and promote C’s welfare.
- (3) The responsible authority must include in C’s care plan (or where regulation 47B(4) applies, the detention placement plan) details of the advice, assistance and support that the responsible authority intend to provide for C when C ceases to be looked after by them.
- (4) Subject to paragraph (5), where C has been a looked after child for at least 20 working days, any decision to cease to look after C must not be put into effect until it has been approved by a nominated officer.
- (5) In any case where C is aged 16 or 17 and is not in the care of the local authority, the decision to cease to look after C must not be put into effect until it has been approved by the responsible authority’s director of children’s services.

- (6) Before approving a decision under paragraph (4) or (5), the nominated officer or director of children's services must be satisfied that—
- (a) the requirements of regulation 9(1)(b)(i) have been complied with
 - (b) ceasing to look after C will safeguard and promote C's welfare,
 - (c) the support the responsible authority intend to provide will safeguard and promote C's welfare,
 - (d) C's relatives have been consulted, where appropriate,
 - (e) the IRO has been consulted, and
 - (f) where appropriate, regulations 40 to 43 have been complied with.

2. The Children Act 1989 guidance and regulations, Volume 2: care planning, placement and case review

The Guidance now reads as follows:

Ceasing to look after a child

- 5.1. This chapter outlines the planning requirements that responsible authorities should follow so that looked after children are properly prepared and ready for the time when they will no longer be looked after.
- 5.2. Children will cease to be looked after for many different reasons. They do not cease to be looked after simply as a result of a move from a regulated placement in, for example, foster care or a children's home, to an unregulated one, perhaps in 'supported lodgings'.
- 5.3. Where responsible authorities are looking after older children making the transition to adulthood, there is a need for the authority to have arrangements in place to support effective planning so that the transition is positive and, so that where the young person remains entitled to care leaving support, there is a continuing focus on working with the young person and other agencies to achieve the best possible outcomes.

Children accommodated under section 20

- 5.4. Children who are accommodated under section 20 of the 1989 Act may be particularly vulnerable. They may be removed from accommodation by parents at relatively short notice, they may be returned to parents because of a placement breakdown and some will return to accommodation within a relatively short time. Unlike the return to parents for a child on a care order, the child loses looked after status and his/her accompanying entitlements to supports and services upon leaving the accommodation provided by the responsible authority.
- 5.5. Where a child who is not an eligible child ceases to be looked after because they return home, the child will be a 'child in need' and a plan must be drawn up to identify the supports and services which will be needed by the child and family to ensure that the return home is successful **[regulation 39]**. This should take into account the child's needs, the parenting capacity of those with parental responsibility and the wider context of family and environmental factors, reflecting the child's changed status. Where possible and appropriate, a review should be held in order to ensure that the plan to be drawn up will be appropriate and that all agencies concerned appreciate and act on their roles and responsibilities when the child is no longer looked after.

Considering ceasing to look after a child

- 5.6. Where the plan is for a child to return to the care of their family when they cease to be looked-after, there should be a robust planning and decision making process to ensure that this decision is in the best interests of the child and will safeguard and promote their welfare **[regulation 39]**.
- 5.7. In making the decision to cease to look after a child, the responsible authority must assess:
- Whether the proposed arrangements for the child's accommodation and maintenance when they cease to be looked-after are suitable; and
 - What services and support the child, and where the child is returning home, the parent, might need when they cease to be looked-after **[regulation 39 (2)(a) and (b)]**.
- 5.8. The responsible authority must speak to or otherwise ascertain the child's wishes and feelings about the proposed plan for their care when they are no longer looked-after **[regulation 39 (2)(c)]**.
- 5.9. Where the local authority is working with the parents to support a child to return home it is important to consider what support and services might be made available to parents. Local authorities should set out what support and services will be provided following reunification and ensure that the child and parents understand who to contact for support **[regulation 39(3)]**.
- 5.10. The local authority has general duties **[regulation 42]** to undertake an assessment of an eligible child's needs as they transition to independence, and to prepare a plan setting out how these needs will be addressed **[regulation 43]**. Some eligible children will return to the care of their parents. In such cases considerations under regulation 39 should include, but not duplicate, those under regulation 42; regulation 39 has a focus on the support that may be provided to parents during the transition and beyond reunification.
- 5.11. Working Together sets out the framework for local authorities providing early and ongoing support to families, including continuous assessment, support and review of services, where appropriate.

Decision making

- 5.12. Where a child has been looked-after for at least 20 working days, the decision to cease to look after her/him must not be put into effect until it has been approved by a nominated officer **[regulation 39(4)]**. Where the local authority are considering ceasing to look after a child aged 16 or 17 years, who has been accommodated under section 20 of the 1989 Act, this decision must not be put into effect until it has been approved by the director of children's services **[regulation 39(5)]**.
- 5.13. Before granting this approval the nominated officer or director of children's services must be satisfied that:
- Child's wishes and feelings have been ascertained and given due consideration;
 - Decision to cease to look after the child will safeguard and promote their welfare;
 - The IRO has been informed; and
 - Where the child is an eligible child the appropriate requirements have been met **[regulations 40 – 44]**.

- 5.14. Some children will be looked-after for very short periods, for example due to a family crisis or parental illness. While it will not be necessary to seek nominated officer approval to cease to look after a child in these circumstances, the authority must be satisfied that this is in the child's best interests and that the proposed arrangements will safeguard and promote the child's welfare.

3. Working Together to Safeguard Children, March 2015

The revised Working Together 2015 contains several references to children returning home from care, including a flow chart and guidance about good assessment practice. It also includes the following box. For a full understanding of the changes in Working Together in relation to children returning home from care, please refer to the whole document.

Children returning home

There are three sets of circumstances where a child may return to live with their family but only in two of these do children cease to be looked after. This section covers circumstances where a child is no longer looked after, but a decision has been taken that local authority children's social care will continue to provide support and services to the family following reunification.

Where the decision to return a child to the care of their family is planned, the local authority will have undertaken an assessment while the child is looked after – as part of the care planning process (under regulation 39 of the Care Planning Regulations 2010). This assessment will consider the suitability of the accommodation and maintenance arrangements for the child and consider what services and support the child (and their family) might need. The outcome of this assessment will be included in the child's care plan. The decision to cease to look after a child will, in most cases, require approval under regulation 39 of the Care Planning Regulations 2010.

Where a child who is accommodated under section 20 returns home in an unplanned way, for example, the decision is not made as part of the care planning process but the parent removes the child or the child decides to leave, the local authority must consider whether there are any immediate concerns about the safety and well-being of the child. If there are concerns about a child's immediate safety the local authority should take appropriate action, which could include enquiries under section 47 of the Children Act 1989.

Whether a child's return to their family is planned or unplanned, there should be a clear plan that reflects current and previous assessments, focuses on outcomes and includes details of services and support required. These plans should follow the process for review as with any child in need and/or child protection plan.

Action to be taken following reunification:

- Practitioners should make the timeline and decision making process for providing ongoing services and support clear to the child and family.
- When reviewing outcomes, children should, wherever possible, be seen alone. Practitioners have a duty to ascertain their wishes and feelings regarding the provision of services being delivered.
- The impact of services and support should be monitored and recorded, and the help being delivered should be reviewed.

Annex 11

Case eligibility and fit with court timescales

Return to whom?

The Framework is primarily concerned with improving outcomes for those looked after children who return to live with their **parents**. For some children this may mean a return to a parent/s they have previously lived with. For other children, this may mean they have been removed from one parent but 'returned' to another. When a child has suffered significant harm it is particularly important for the assessments to distinguish between the capabilities of the abusing parent and the potentially protective parent. Where relevant, fathers should be included in the assessments and any subsequent planning.

This Framework applies in all cases where a child ceases to be looked after on return home. This includes **accommodated children who return home** and those where the **care order is discharged**. The Framework can also be used when the plan is for a child to remain looked after, and **'placed with parents'**. Any support and services provided to these children will be included in the care plan and monitored through the review process, with the oversight of the IRO.

Other relatives/friends (kinship care)

For some children a return home will not be possible and kinship care may be considered. In these cases workers should use kinship care assessments to decide if this would be in the child's best interests.

Timescales

The assessment and the 26-week time limit in court (The Public Law Outline)

The Framework can fit within the 26-week time limit for most cases. The following considerations should be taken into account.

- The Framework can be used at edge of care/ accommodation.
- Return home should be considered as a possible permanence option for children accommodated under Section 20 as early as possible. Assessing return home early on will help with timescales if the case does end up in court
- For those children who enter care on care orders, the Framework can fit within the 26-week time limit.
- There may be some cases where an extension to the 26-week time limit is required. For example, cases where a parent is showing promising signs of change, but not enough time has elapsed to test if the changes are sustainable. Several family court judges in areas using the Framework, have confirmed in conversation that they would consider a time-limited extension to 26 weeks if they were convinced that this would allow a definitive decision to be made on the parent's ability to care for their child. These decisions would be made by the court with the child's timeframe in mind.

We advise strategic leads and managers to engage CAFCASS, the judiciary and local authority legal partners in this Framework, the rationale behind it, and how it will be implemented in the local authority.

Annex 12

Tips for working with children and young people

Engage

It is essential to engage children and young people in the process as soon as possible. The parent/child-friendly Risk Classification Table can be used to explain the process and it needs to be made clear to all involved in the assessment that the best interests of the child/young person are the paramount consideration in the assessment.

Tools

Be creative when it comes to engaging and gathering a child/young person's wishes and feelings. Some examples are:

- Work sheet – Three Islands, Three Houses, Magic Wand
- Play therapy techniques
- Undertaking activities such as playing a game, sport, baking, driving, that allow for free conversation and relationship building.

Engaging trusted adults, such as foster carers, as a source can help in both supporting the child to build a positive relationship with their social worker and speaking for them when they are unable. When a child is pre-verbal, workers can predict what a child would want and need for their future and can use the views of others and observations of attachments to formulate views. Remember the assessment is not a one-off event, rather a process and therefore space needs to be given for children/young people to change their minds.

Taking a solution-focused approach

There is a large body of clinical research that shows that solution-focused brief therapy can be very effective, including for children and young people.⁹⁴ NSPCC's Face to Face service for children in and on the edge of care showed positive results for all ages of children between 5 and 18 including a significant reduction in clinical levels of distress from 58% to 15%.⁹⁵

The NSPCC have developed a range of solution focused tools, activities and worksheets which can be used to elicit a child's views and to support conversations about the future, what needs to change, the journey, the child's strengths and their support network.

The following materials from the toolkit may be particularly useful when considering return home from care. Practitioners can access the tools and the accompanying activities here <http://www.nspcc.org.uk/globalassets/documents/publications/solution-focused-practice-toolkit.pdf>.

- The **Traffic light picture** on page 100 of the toolkit could be used to describe the risk classification framework to a child. The child could write on the worksheet to say what they think risks/ protective factors are in relation to going home.
- **Identifying the child's strengths:** See worksheets on pages 93-95
- **Looking into the future:** See worksheets on pages 98, 101 and 105

94 Fernandes (2015).

95 Fernandes (2015).

- The **Changing the channel** worksheet on page 102 is about what needs to change
- The **Climbing a mountain tool** on page 106 establishes where the child is now in relation to their own goals.
- The ladder on page 107 can be used to discuss scaling questions
- **The solution team** on page 109 is about the support network – who is important to the child/ who can help them once they return home?

Context

Be mindful of the child/young person's circumstances throughout the process. Issues such as placement moves, emotional wellbeing, experiences of school and experiences of contact will impact on engagement, responses during assessment and ability to understand decision-making.

Professional judgement

When analysing work with children/young people remember that, although it is important to accurately record the expressed wishes and feelings of children/young people, social workers should use professional judgement as well. This may mean suggesting a course of action that is different from the child's view or making sense of the child's silence.

Someone to trust

The social worker is responsible for making decisions about the child's life, and needs to have a relationship with the child. However, the child may have closer, trusting relationships with other adults, such as caregivers, staff at school or relatives. Social workers may also be able to arrange for children to be offered an advocate from the start of the assessment process. The aim is for children to have someone to talk to who they can trust. The social worker should

ensure that these people are involved in the return home process, and know to report any safeguarding concerns to them.

Observe and interpret

Some children, especially those affected by childhood abuse and neglect may find it difficult to express their thoughts and feelings in a way that is easy for the social worker to capture. Recent research on older children's experience of abuse shows that some children will not 'tell' someone about the abuse, but may try and ask for help in other ways. This can sometimes be through exhibiting behaviour that others find challenging. The social worker needs to try and understand and interpret these behaviours.

Decisions

Communicate outcomes of the assessment with children in a timely and clear manner. A child/young person's version of the report can be used to aid this process, as can tools such as toys and pictures. Think carefully about endings and include the multi-agency network in the process where appropriate. Consider writing a later life letter to explain what has happened, that can be used by parents or caregivers to aid children's understanding in the future (see Annex 23).

Reunification plans, support and monitoring

Children and young people should be involved, as far as possible, in creating the plans for reunification. They should be consulted about what *they* think their parents need to change, and how these changes may best supported and sustained. Children and young people should be able to express their views on the support that they need to prepare for returning home. The social worker needs to ask them for feedback about any services they are receiving. The social worker will maintain close contact with the child in the build-up to and on return home, allowing space for children to express concerns.

Annex 13

Special considerations when assessing return home from care in relation to babies

There are particular considerations that practitioners need to bear in mind if the case involves a baby or very young child. Practitioners must think very carefully about the risks associated with the child returning to parents, and the need for permanence decisions to be made as swiftly as possible to allow the child to develop a secure attachment with a caregiver.

Infants have an increased risk of vulnerability

Babies and very young children are entirely reliant on their caregivers and are therefore extremely vulnerable. **45 per cent** of serious case reviews in England relate to babies under the age of 1.⁹⁶ In England and Wales babies are **eight times** more likely to be killed than older children.⁹⁷

Exposure to maltreatment can overload a baby's stress response, with lifelong consequences. This toxic stress – a baby's 'fight or flight' stress response to maltreatment – can negatively impact their brain architecture, and their psychological and behavioural development.

For more information please see <http://www.nspcc.org.uk/services-and-resources/research-and-resources/all-babies-count/> and <http://www.nspcc.org.uk/services-and-resources/research-and-resources/all-babies-count-drug-alcohol/>

Behavioural Observation and Interpretation

Behavioural observation is a vital mechanism for assessing pre-verbal children and those with disabilities. Behaviour is the only way that very young and non-verbal children can communicate their distress. Practitioners need to observe and interpret infant behaviour and the quality of the interaction between the child and the parent, and the child and the care-giver. Teams may need to bring in workers who have had training in reciprocity, attunement and attachment, including colleagues from CAMHS.

96 Department for Education (2010) *Building on the learning from serious case reviews: a two year analysis of child protection database notifications 2007-2009*.

97 Smith, K (ed.) *et al* (2011) *Homicides, firearms offences and intimate violence 2009/2010: supplementary volume 2 to Crime in England and Wales 2009/2010*, London, Home Office.

Opportunities and timescales for babies and young children

There are opportunities to repair damage inflicted on babies and very young children, with the right understanding, care and stable relationships. Timescales are different for infants than for older children because the damage becomes indelible far more quickly and therefore parents do not have as long to demonstrate positive change.

Return home should only be considered for infants in cases where parents have acknowledged and overcome their underlying trauma, and learnt to understand and respond appropriately to their baby's needs and behaviours. Supporting parents and their

relationships with their infants is a highly specialist area of practice that needs to involve colleagues from mental health teams. When parents are struggling with issues such as substance misuse, domestic abuse and/or mental health problems, they may not be able to make the changes needed within their child's timeframe.

For more information see Brown and Ward (2013) *Decision-Making within a child's timeframe*, Childhood Wellbeing Research Centre. London, Institute of Education. https://www.gov.uk/government/uploads/system/uploads/attachment_data/file/200471/Decision-making_within_a_child_s_timeframe.pdf

Annex 14

Assessing risks and protective factors and planning for positive outcomes for adolescents in relation to return home from care

Recent child sexual exploitation cases revealed a culture across services that did not recognise adolescents as vulnerable children and victims of abuse and neglect. Previous research had shown that a focus on adolescents' challenging or risk-taking behaviour can lead to service responses which fail to recognise and respond to adolescents' experiences of maltreatment⁹⁸. The NSPCC have published messages from serious case reviews involving adolescents which can be found here <http://www.nspcc.org.uk/preventing-abuse/child-protection-system/case-reviews/learning/teenagers>.

Messages from research and practice highlight that practitioners often feel that 'nothing can be done' when a young person accommodated under Section 20 returns home of their own accord.⁹⁹ However the reunification breakdown for adolescents is high, and those children who oscillate in and out of care/accommodation experience the worst outcomes. It is therefore imperative that the despondency described by workers is replaced by more pro-active child-centred work, which carefully considers the child's best interests.¹⁰⁰

Practitioners implementing the Reunification Practice Framework need to understand the risks faced by young people and to try and place them in stable, safe and nurturing

environments where they can enjoy the rest of their childhoods, whilst preparing for independence. In the context of potential return home from care, practitioners need to assess, on a case by case basis, where the young person is most likely to be safe and well cared for. Practitioners need to consider the risks faced by young people from outside the home as well as within it, assessing risks posed by the wider environment (schools, peers, particular public spaces). Sometimes too risks arise in care, for example from sexual exploitation or peer violence, so practitioners then need to consider the relative risks of continuing to be looked after against the risks of returning home. Parents and foster carers/residential workers may need support to understand and respond to these risks and to strengthen the protective factors. Practitioners may need to coordinate a multi-agency team to mitigate the environmental risk factors.

The guidance below supports workers to have a better understanding of

1. **The risks facing adolescents in order to support decision making**
2. **The approaches most likely to work in supporting adolescents** (either in care/accommodation or at home)

98 Bowyer S. and Wilkinson J. (2013) Evidence scope: models of adolescent care provision, Totnes, Research in Practice.

99 See also Farmer E. and Patsios D. (2015) Evaluation Report on Implementing the Reunification Practice Framework, Bristol, University of Bristol.

100 Sinclair *et al* (2007).

This guidance is largely taken from a Research in Practice and Association of Directors of Children's Services report; Hanson and Holmes (2014) *That Difficult Age: Developing a more effective response to risks in adolescence* and Jo Dixon's report on *Adolescents on the Edge of Care*.¹⁰¹

1. Understanding the risks facing adolescents to support decision-making

The prevailing view that adolescents will be resilient and therefore require less protection because of their age is now being challenged by a more complex understanding of the variability and limitations of resilience. Some research suggests that maltreatment in adolescence may actually have more wide reaching and serious effects than maltreatment experienced in early childhood.¹⁰²

We now understand that some adolescents who have experienced earlier maltreatment may develop maladaptive responses, which place them at further risk of harm by others and themselves¹⁰³ or lead to angry or violent outbursts or 'defensive aggression' that are perceived as problematic or antisocial behaviours.

Neglect

In terms of risks from parents or carers, practitioners need to be mindful of neglect which features more prominently for 11 to 15-year-olds in Serious Case Reviews than for any other age group.¹⁰⁴

Peer-on-peer abuse

There is increasing evidence about the levels of violence and abuse between young people in the UK. **Looked after children**, those with **intra-familial abuse in their histories**, or those living with **domestic abuse**, are said to be more vulnerable to peer-on-peer abuse.¹⁰⁵ There is increasing recognition of the importance of environmental factors beyond the home such as schools, gangs, peer groups, public spaces.¹⁰⁶ This briefing from the expert charity Ms Understood supports practitioners to identify and respond to peer on peer abuse. <http://www.msunderstood.org.uk/assets/templates/msunderstood/style/documents/MSUPB01.pdf>.

Child sexual exploitation

The University of Bedfordshire have developed 12 short films highlighting the latest research on child sexual exploitation. <http://www.beds.ac.uk/ic/films>

The NSPCC website contains links to research, guidance and resources on child sexual exploitation.

The table below from the *That Difficult Age* (Hanson and Holmes 2014) suggest some of the risks faced by adolescents. Practitioners should consider the presence of these risk factors and whether they can best be managed in care/accommodation or at home.

101 Hanson and Holmes (2014), Dixon *et al* (2015).

102 Thornberry *et al* (2010).

103 Dutton and Painter (1993); DePrince (2005) in Hanson and Holmes (2014 p19).

104 Brandon *et al* (2013).

105 Berelowitz *et al* (2012), Catch 22 (2013).

106 Barter *et al* (2009), Beckett *et al* (2013), Firmin (2011), Berelowitz *et al* (2012).

Some risks faced by adolescents

Child Protection Category	Some of the risks adolescents face
Sexual abuse	Sexual exploitation by gangs or groups Sexual abuse by peers Duress / coercion to sexually exploit / abuse others Online sexual abuse Intrafamilial sexual abuse Sexual abuse by those in positions of trust or authority
Physical abuse	Family violence – adult(s) to adolescent Mutual family violence between adult(s) and adolescent(s) Gang-related and community violence Violence from relationship partner
Neglect	Neglect from family members including rejection and abandonment, and parental mental health or substance misuse problems that disrupt parenting capacity and incur caring responsibilities on part of the young person Overly restrictive parenting Neglect in custody
Emotional abuse	Emotional abuse from family members towards adolescents Emotional abuse between family members and adolescent Extensive bullying by peers and/or online Exposure to other risks listed above and below Living with domestic abuse between parents Emotional abuse from relationship partner
None of the above	Homelessness Self-harm including deliberate self-harm, suicide attempts, eating disorders Gang involvement Substance misuse

Source: Hanson and Holmes (2014) *That Difficult Age, Developing a more effective response to risks in adolescence*

2. The approaches most likely to work in supporting adolescents (either in care/ accommodation or at home)

That Difficult Age argues that services and approaches should 'go along the grain' of adolescent characteristics, rather than oppose them. The list below, adapted from the report offers advice for practitioners about how to effectively support adolescents. Practitioners can share these approaches with the adults responsible for caring for the child, be it parents or alternative carers.

1. **Peer groups:** Whilst peers can be a risk factor, they can also be strength. Research shows the importance of young people having support from friends throughout the return home process. Safe online sources of peer support may also be useful such as Childline message boards.
2. **Education about child sexual exploitation:** Individuals who sexually exploit children rely on the child's lack of knowledge of their rights, and their inability to seek help. Educating children, young people and their parents and carers about the risks is therefore crucial. PACE (Parents against child sexual exploitation) have resources on their website to support parents – www.paceuk.info

3. **Promoting opportunities for young people to increase their self-belief** such as; learning new skills, helping others, or participating in decisions that affect them. A solution-focused approach can be used to elicit a child's views and to support conversations about the future, what needs to change, the journey, the child's strengths and their support network. Annex 12 describes tools and activities created as part of the Face to Face brief solution-focused therapy service for children in and on the edge of care.¹⁰⁷
 4. **Authoritative parenting:** This parenting style is characterised by love and warmth paired with actively communicated boundaries and high expectations. Establishing authoritative parenting is *"one of the most promising routes to reducing harm – for example via intensive family interventions and the relational safeguarding model"*.¹⁰⁸
 5. **A relationship with a trusted adult:** Research shows the central importance of the young person's relationship with their key worker in reducing risk and building resilience.
 6. **Understanding and working with young people's barriers to engagement** (see table below)
 7. **Persistent, outreaching relationships** that meet the young person's immediate needs, including practical needs such as leisure activities, securing a place at college
 8. **Supervision and peer support for workers.**
- Despite good intentions on the part of many staff, adolescents can be incredibly challenging to engage. The following table from *That Difficult Age* summarises some of the barriers to engagement and strategies which may overcome them.

Reasons why it may be challenging to engage adolescents and suggested strategies

Driver of engagement challenge	Suggested initial strategy
Ego-syntonic risk (<i>'a part of me wants to keep this problem'</i>).	Explore what needs the risk is meeting and aim to meet them in other ways. Consider Motivational Interviewing to help a young person connect with what they most want in the longer term and to develop their belief in their ability to change (Barnett <i>et al</i> , 2012; Feldstein and Ginsburg, 2006).
Interventions 'go against the grain' of adolescent developmental drivers.	Restructure interventions to 'go with the grain' – involve high levels of adolescent participation, build social capital, include some risk-taking.
Adolescent fears that fragile coping mechanisms will be destabilised.	Identify and discuss the fears; in collaboration, formulate a plan to avoid destabilisation.
Adolescent fears feeling worse about her/himself.	Use strengths/resilience/solution-focused strategies.
Adolescent has low trust or belief in adults' ability to help.	Develop a persistent, outreaching relationship that helps to meet the young person's immediate needs, for example involving advocacy or practical help.
Professional demoralisation; spirals in operations that give implicit 'permission to give up'.	Ensure supportive supervision focused on complex issues, such as choice and engagement, in parallel with being part of a supportive network of workers and agencies.

Source: Hanson and Holmes (2014) *That Difficult Age, Developing a more effective response to risks in adolescence*

¹⁰⁷ Fernandes, (2015) Evaluation of the Face to Face Service, NSPCC.

¹⁰⁸ Hanson and Holmes (2014).

Annex 15

Case study showing the impact of the assessment for young people who ‘walk themselves home’

The Framework stipulates that assessments should still be conducted on cases where the young person has / or is likely to walk themselves home **or where the parent takes the young person home without children’s services agreement**. The following case study shows that the assessment and ensuing support plan was beneficial to securing a successful return home.

The Case

- Young Person A was aged 15 and was accommodated under Section 20.
- He had clearly stated that he intended to return home to his mother in the school holidays as he wanted to spend the rest of his childhood at home and he did so.
- At this stage he had been having weekly overnight contact and his parents had separated.
- It was agreed an assessment of his mother would still take place.
- The assessment concluded that the level of risk should he return home was medium.

Although it was recognised that the young person would have returned home regardless of the outcome of the assessment, the assessment was still valuable for the following reasons:

- The assessment provided **a voice for the young person** and gave the message that his request was being seriously considered.
- The assessment **allowed his mother time** to process what had happened in the past and **to fully understand why the child had been removed in the first place**.

- The assessment allowed his mother **to see the changes** she had made in her life and **increased her own confidence** in parenting.
- The assessment clearly **identified protective factors** in the family unit.
- The assessment provided **clarity around any remaining risks** – for example the father who continued to have contact with the young person but who was misusing drugs.
- **A clear plan could be formulated based on the known protective and risk factors**, drawing on the families’ strengths and outlining how the family would be supported to overcome the challenges and risks identified.
- The **plan outlined how professionals could support the family** and address and monitor risks.
- The assessment and subsequent plan provided a benchmark for reconsidering protective and risk factors in review meetings once the young person had returned home. These in turn were used to update the plan.

The outcome was the young person successfully returned home and continues to do well. He attends school daily and is signed up to be an apprentice.

Annex 16

Engaging parents

The role played by the worker is integral to supporting parents to make changes.

Almost all the parents involved in the assessment will have experienced children's services assessment processes and services. Many parents (though not all) are wary of social services involvement and some will be actively resistant. Workers have to try to disentangle whether this resistance also represents resistance to change. The way that social workers approach parents can inflame or reduce their resistance to engagement. Where social workers are confrontational, parents are more likely to challenge them, or to feign cooperation. The battle against children's services can become the central focus, rather than the child.¹⁰⁹

However, there are positive messages from research about how social workers can mitigate parental resistance and develop positive relationships with parents.

"if social workers can establish a strong relationship with parents that is characterised by honesty about what needs to change and why, sensitivity and a willingness to listen to parents' points of view, respectful uncertainty ... and supportive use of power, they may be better able to help parents become motivated and engage in services"¹¹⁰

The motivational interviewing approach could support constructive relationships with parents, as it focuses on collaboration, and the parents' views of how change may happen.¹¹¹

Research also highlights the importance of social workers providing **practical support** to parents, for example helping to sort out housing problems. This has to be provided alongside assessment from the moment a referral is made that may result in a child being looked after. **It is particularly important once a decision is taken to work towards reunification to ensure that lack of resources does not jeopardise the plan for safe and stable return home.** Since most families to whom a child is returning following being looked after will have been assessed as families of 'children in need' it will be important to consider the needs of all family members, including siblings or step-siblings who are not looked after.

The social worker must understand the diverse needs and backgrounds of the families involved and they should challenge any barriers to engagement. For example, the worker must ensure that they can communicate effectively with the families and vice versa, using advocates and interpreters where necessary. Workers must be sensitive that apparent resistance to change may be due to cultural factors.¹¹²

109 Thoburn (with Making Research Count Consortium) (2009a) http://www.c4eo.org.uk/themes/safeguarding/files/safeguarding_briefing_1.pdf and Thoburn (2010).

110 Ward et al (2014, p.143).

111 A formal evaluation of the effectiveness of motivational interviewing within child protection is currently being undertaken: Forrester (forthcoming).

112 Chand and Thoburn (2005), Thoburn et al (2005).

Annex 17

Parents with learning disabilities

Assessing parents with learning disabilities

Ability to take part in the assessment

Workers need to make a judgement about whether or not parents can take part in the assessment, or whether a referral should be made for a specialist assessment such as a PAMS (Parent Assessment Manual) assessment.

Communication

Social workers need to explore different ways of communicating information to parents who have learning disabilities, for example using film, audio or pictures. Information and documents may need to be broken down into shorter/smaller documents. Jargon should be avoided and whilst there may need to be an 'official' document (e.g. Court report) parents may need their own version to be accessible in language/media they can fully grasp and understand. Workers should consider referring parents to an adult advocacy service.

Capacity to change

There is evidence to suggest that parent training programmes, home-based interventions and supportive peer networks can potentially support adults with learning disabilities to parent adequately. However, social workers need to be mindful that **if the parent also has mental health problems, this represents a significant risk factor** for future maltreatment of children (see p. 25). There are mixed messages from research about the ability of parents with learning disabilities to *retain* parenting skills and adapt to new situations. All parents with learning disabilities are likely to need ongoing support to adapt to new challenges as their children grow up.¹¹³

¹¹³ Ward *et al* (2014).

Annex 18

Top Tips for assessment

1. **Ask:** Assessing means asking questions – it sounds simple but ask ask ask! Cover a wide range. Don't shy away from difficult areas. Ask open questions but go into more detail where necessary. Plan some questions/topics but respond to arising matters.
2. **Ask even the most basic/obvious questions:** Parents/others may not offer information proactively so you need to explore ... for example: 'Do you have a partner at the moment?' 'Does your partner live with you or somewhere else?' 'Has your partner ever hurt or threatened you or your children?' 'How much do you drink every day? Do you take any drugs and how often?' 'Does anyone else live with you?'
3. **Challenge!** And gauge your interviewee's reaction when you do. Retain 'respectful uncertainty',¹¹⁴ acknowledge when you are not confident they are telling the truth or where there might be another interpretation of an incident or piece of information. Think the unthinkable – see things from all angles. Do not make assumptions but check out what you have understood. Be mindful of the chronology.
4. **Find out about the family history** and the quality/significance of relationships.
5. **Observe:** Look at body language, interactions, reactions. Look at physical and emotional presentation. See the parents at home – what are the conditions like? Look at the child's bedroom. See them interacting with the child – what are the dynamics? Analyse any observations.
6. **Use practical and visual tools:** For example drawing up an ecomap and genogram with the parent, using the needs jigsaw or cards, worksheets and timelines. Adapt your approach to the parent's own particular learning style/ability.
7. **Ascertain the parent's reflections,** not just their narrative. What do they feel now about what's gone before? What do they want to do differently now? Go beyond the facts to find out how the parent thinks they are doing and how they apportion responsibility for the child's past and future.
8. **Clarify what they understand** about why the child is Looked After, what the local authority/court needs to see changing, why the assessment is taking place.
9. **Draw on your knowledge** of child development, outcomes for children who experience abuse and neglect, the impact of domestic violence, parental drug and/or alcohol use etc. Refer to the Jones model throughout. Keep yourself informed.
10. **Draw together and analyse** – the assessment should not just be a report of what you have found out, but of what it all means and how you reached the risk classification. Do some factors interact with others? For example, the lack of wider family support compounds the impact of Mum's learning disability on her parenting. Or Dad's confidence has increased significantly since he has moved into his own flat. Keep the child at the centre of all your asking, thinking and analysis.

114 Laming (2003).

Annex 19

Assessing parental capacity to change

This annex contains information for workers and supervisors to consider when assessing parental capacity to change. It includes information from the reunification literature and serious case reviews, guidance on standardised measures, and presents helpful advice from two assessment models: Platt and Riches (2015) and Dawe and Harnett (2007).

Understanding previous maltreatment

It is important to clarify what factors were associated with the previous maltreatment, for example, underlying maternal depression, domestic violence, lack of understanding of the child's needs, poor parenting capability, learning difficulties combined with alcohol misuse, other factors or a combination of these. It is also vital that a view is taken on who was the abuser or person responsible for the maltreatment, including those who failed to protect the child from abuse/neglect.

Motivation to change

The 'Factors associated with future harm' table on p. 25 – Jones *et al* (2006) and White *et al* (2015) – highlights a cluster of factors associated with limited parental capacity for change:

- i. **Absence of acknowledgement**
- ii. **Lack of cooperation**
- iii. **Inability to form a partnership with professionals.**

The social worker needs to understand the family's motivations and wishes about reunification and the reasons for any previous reunification breakdowns. When parents are strongly motivated to resume care of the child this is associated with successful reunification, whereas parental hostility or ambivalence to return home is associated with failure. However, the underlying reason for motivation needs to be clear: for some parents (especially those with controlling personalities) it may lie in a determination 'to prove the social care practitioners or courts got it wrong'.

False / disguised compliance

A number of writers¹¹⁵ and recent serious case reviews¹¹⁶ warn of the risks of false compliance by parents which can result in them apparently doing all the right things to get a child returned home. **Babies and very young children are at particular risk from a lack of timely intervention due to disguised compliance.** Once the child is returned home parents may continue in false compliance or refuse access to those monitoring the child's welfare and safety.

Disguised compliance can take a number of forms:

- Parents engage well with one set of professionals to deflect attention away from their lack of engagement with others
- Parents criticise professionals
- Pre-arranged home visits present the home well with no evidence of other adults living there
- Parents promise to comply but then avoid contact with professionals

115 Brandon *et al* (2008), Thoburn (2009a).

116 <http://www.nspcc.org.uk/preventing-abuse/child-protection-system/case-reviews/learning/>

Disguised compliance is risky because:

- It can result in drift in the case
- It can lead to a focus on the adults and their engagement with services, rather than on keeping the child safe
- Professionals can be over optimistic

Practice points from the serious case reviews

- Establish facts and evidence; adopt 'respectful uncertainty' about what people say
- Case history can evidence patterns
- Recording should retain focus on child
- Focus on outcomes, not process, intent or participation. Ask 'so what?'
- Use reflective supervision

Standardised tools and measures

The use of standardised tools is likely to assist social workers in assessing capacity to change and deciding whether or not a child can be reunified. Barlow *et al* (2012) undertook a systematic review of models and tools for analysing significant harm. They found that two UK tools, the **Graded Care Profile**¹¹⁷ and **SAAF (Safeguarding Assessment and Analysis Framework)**¹¹⁸ provide comprehensive descriptors alongside a comprehensive set of domains which assist practitioners to make sense of the data they collect. These could be used on more than one occasion to track changes in parents (for more on the Graded Care Profile, see following section on Neglect).

A range of assessment tools are available to enable practitioners to make valid and reliable judgements in relation to a range of aspects of family functioning. A number

of these tools were published alongside the **Assessment Framework**¹¹⁹ and they include, for example, the **Strengths and Difficulties Questionnaire**¹²⁰ and the **General Health Questionnaire**,¹²¹ both of which are easy to use and provide useful information about clinical levels of difficulty. These may be useful to use on one occasion to determine the seriousness of children's emotional and behavioural difficulties (the SDQ) and the level of stress in parents (the GHQ).

Barlow *et al* (2012) consider that at least one practitioner within each assessment team should have the skills to use such methods and their use should be included in basic and continuing training for social workers.

Annex 20 on neglect contains more detail on the Graded Care Profile and the Platt and Riches model below suggests measures which can be used to assess particular factors.

Framework of factors that affect behavioural change – adapted from Platt and Riches *Assessment of Parental Engagement and Capacity to Change, Practice Handbook (Pilot Version), 2015, University of Bristol*

The University of Bristol have developed a Practice Handbook to support social workers to assess parental engagement and capacity to change, which can be accessed via their website www.capacitytochange.org.uk.

The authors suggest that workers focus the assessment on five factors which affect behaviour change. The table below, adapted from the handbook, lists the factors alongside questions that social workers can pose, and standardised tools they could use.

117 Srivastava and Polnay (1997).

118 Bentovim *et al* (2009, 2010).

119 DH Cox and Bentovim (2000).

120 Goodman (1997).

121 Goldberg and Hillier (1979).

Factors affecting capacity to change

Factors affecting behaviour	Questions social worker can use	Examples of standardised tools
Priority and relevance	<p><i>What do you think is the most important change for you to make to improve your child's life?</i></p> <p><i>What would be the good and not so good things that would happen if you made these changes?</i></p> <p><i>How important do you think the changes are that social services are asking you to make?</i></p> <p><i>(Use scaling questions) If you're thinking about (issue of concern, eg alcohol), where 10 is the top priority and 0 is bottom, where would you rate it?</i></p> <p><i>If you had a magic wand to change one aspect of your life, what would it be?</i></p>	Personal Aspirations and Concerns Inventory
Knowledge and skills	<p>(Check for literacy levels, how best to communicate information, need for interpreters or advocates)</p> <p><i>Explain to me what you think the concerns are</i></p> <p><i>Can you tell me about one part of parenting that you feel you do well? Tell me about a specific situation</i></p> <p><i>Can you tell me about one part of parenting that you find most difficult. Tell me about a specific situation</i></p> <p><i>What happened? What was the consequence?</i></p> <p><i>What needs to happen now?</i></p>	Parenting Daily Hassles questionnaire
Motivations and intentions	<p><i>What is your main reason for making these changes?</i></p> <p><i>Who will benefit from the changes?</i></p> <p><i>What/who has helped you in the past?</i></p> <p><i>Do you think you can work with social services?</i></p> <p><i>The report says xx what is your perspective on the situation?</i></p>	<p>Depression Anxiety and Stress scale</p> <p>Adult Well-being scale</p>
Habits and automatic reactions	<p><i>Can you give an example of a regular stressful time related to parenting? How do you respond?</i></p> <p><i>How long have you been behaving like this?</i></p> <p><i>Can you see yourself behaving differently</i></p>	Difficulties in Emotional Regulation Scale
Contextual factors	<p><i>Are there practical or financial issues that are preventing you from accessing support eg timing, travel, childcare, work?</i></p> <p><i>What support from family and friends do you think you need to make and sustain positive changes?</i></p>	<p>Eco-map and genogram</p> <p>Multidimensional Scale of Perceived Social Support</p>

Source: Adapted from Platt and Riches, *Assessment of Parental Engagement and Capacity to Change*, 2015

The handbook also includes these questions that can be used in reflective supervision:

- *Are we working to support the parents' senses of autonomy (as far as is feasible), their connectedness with formal and informal support networks, and their self-belief (in their own abilities to change)?*
- *Are we working collaboratively to help the parent(s) identify goals, and give them the means to achieve the necessary changes?*
- *Are we using the right types of interventions for the identified needs?*
- *Where are the points of difficulty in the relationships between parents and services, and what can be done to address them?*
- *Is the parent's (or worker's) attachment style affecting our working relationship?*
- *How can I adapt or modify my style to acknowledge the parent's style of relating, and improve our working relationship?*
- *What is the current situation regarding the practical engagement of the parent(s) e.g. are they attending sessions, at home for visits, working towards goals?*

The Dawe and Harnett Capacity to Change Model

A promising approach to assessing parental capacity to change has been advocated by Harnett (2007) and Dawe and Harnett (2007). An assessment that specifically addresses the parents' **capacity to change** takes place over a specified period of time and is supported by evidence-based services that ensure that parents have the optimum opportunity to make the necessary changes. Although many parents may be motivated to change, they may lack the ability to actually make the changes. The capacity to change process enables parents to demonstrate that they are capable of making the changes and that they can sustain them over an agreed timeframe.

The Harnett model is based on a four step process, which corresponds to the Reunification Practice Framework stages

Step 1: An assessment of the family's current functioning using a range of standardised tools, which are collated with other data obtained from interviews, observations and multi-agency reports.

This corresponds to Stages 1 and 2 of the Reunification Practice Framework

Step 2: Defining and agreeing measurable goals with the family that address their unique situation and which specify what needs to change.

This corresponds to Stage 3 of the Reunification Practice Framework

Step 3: Provision of an effective (i.e. evidence-based) intervention that is designed to support the family to bring about the change required – this has to address the concerns identified in the assessment and be time limited.

This corresponds to Stage 3 of the Reunification Practice Framework

Step 4: Following the provision of the intervention the final step is to re-administer the standardised tools that were used previously. The standardised tools provide an *objective* measurement of change. This should be considered alongside the worker's analysis of: the extent to which the goals have been achieved, observations, other discussions with the family and reports from other agencies also working with the family. This step will also involve consideration of the factors that have either supported or hindered the parent from achieving the necessary change.

This corresponds to Stage 4 of the Reunification Practice Framework

Annex 20

Neglect

For cases where a child is looked after due to neglect, the social worker needs to understand the reasons for the neglect, the impact on the child, the parents' understanding of this, and their capacity to change.

Reason for neglect

To support parents to make changes the practitioner needs to understand the underlying reasons for neglect. Issues such as domestic abuse, drug and/or alcohol misuse, learning difficulties, depression and stress should be explored through the assessment.

Impact of neglect

There are a number of age-specific tools which can be used to demonstrate the impact of neglect. One of the most common for children under 6 is **Ages and Stages** (<http://agesandstages.com/what-is-asq/>).

This is a very easy-to-use tool which allows developmental milestones to be compared with the child's actual development and can be very powerful in showing not only families but courts the impact of the neglect on the child.

There are fewer tools as the child gets older, however the **Research in Practice Child Development Chart** can be used with families to match their child's development against the expected development and behaviours (<https://www.rip.org.uk/resources/publications/frontline-resources/frontline-child-development-chart/>).

Type and severity of neglect

The Graded Care Profile¹²² scales give workers a numerical grading along a number of domains of family functioning or care of the child: <http://lutonlscb.org.uk/pdfs/gcp.pdf>. This allows a baseline to be measured and then repeated, whilst the child is looked after and then once the child returns home (if they do so). This will give a dynamic view of the care the child is receiving and how it changes once the child returns home. This will allow identification of any deterioration at an early stage. This dynamic process can be used to monitor and measure the parents' ability to implement and sustain the changes required for the child to stay at home.

These tools allow the practitioner to note the areas of neglectful parenting but also those domains where good care is being provided. This is seen to be very positive by parents themselves and by the practitioners working with them. It is important that the history is not ignored, but that the strengths are identified and built on.

Working with parents/Goal setting

Neglect is complex and multi-faceted and the practitioner needs to be clear and structured in their assessment practices. If not they too can be overwhelmed by the number of the problems the families and children face. It is important when the issues are complex that there is focus on those problems which are having the biggest impact on the care of the child and that the suggested changes are achievable, small and incremental.

122 Srivastava and Polnay (1997).

Annex 21

Additional guidance for working with families where reunification will not be possible

Once a decision has been made that reunification will not be possible, the social worker should consider the following:

- Who is the most appropriate person to relay this decision to the parents and to the children?
- Workers should use the adult/child-friendly report (see example in Annex 6) with the simplified risk classification tool to communicate decisions (Annex 2).
- In some cases it might be appropriate to have a **joint session with the parents and child** so that the parents can help explain the decision to the child/ren.
- Some parents will benefit from one or two sessions with a **trusted worker** to discuss the next stage of the life of the child and the role the parents may continue to play in the child's life.
- In some cases it may be beneficial to have a facilitated meeting between **new families and birth relatives** to discuss roles and contact.
- **Life story work for children:** having an understanding of their life history, and the reasons decisions were made supports children's development. At the end of the assessment children are not always able to process all the information provided. Later life letters can be undertaken for all children, whether they are adopted or remain in long-term care. Later life letters need to be factual, accurate and written with a view to an older child reading them (see Annex 23 for an example).

Annex 22

Families who experience multiple removals of their children

There will be some families for whom the decision not to reunify will follow other children having been permanently removed. There will also be families where the decision not to return home the child is the first time they will have experienced permanent removal, but they may share characteristics with families who experience multiple removals.

Local authorities may have particular strategies for trying to reduce the numbers of families experiencing repeat removals. One example of a specialist project is the 'Positive Choices' project (Suffolk Children's Services, 2012).¹²³ It facilitates access to family planning and specialist services for mothers who have had children removed previously on a compulsory basis. The project aims to support women to delay further

pregnancies until they have addressed issues such as substance misuse or intimate partner violence. The project workers engage with mothers about long-acting reversible contraception.¹²⁴ Another example is Pause, a project which works with women who have experienced, or are at risk of, repeat removals of children from their care. Through an intense programme of support, it aims to break this cycle and give women the opportunity to reflect, tackle destructive patterns of behaviour, and to develop new skills and responses that can help them create a more positive future.¹²⁵

The social workers and other professionals involved need to show great sensitivity at this stage, which takes account of parents' feelings of grief and loss, as well as anger towards children's services.

123 http://www.transformingsuffolk.co.uk/files/2012/Childrens%20Trust/cyp_jan_2013_final.pdf.

124 Broadhurst and Mason (2013).

125 <http://www.pause.org.uk/aboutpause/>

Annex 23

Example of later life letter

Hi Lucy

You probably won't remember me but I was a social worker who worked with you and your birth mum, Katie, when you were very little. I wanted to write to you to help you understand why I was involved in your family and the reasons for some of the decisions that were made about your life when you were very little.

Before you read any more of this letter, you might want to think about who is near you now and whether you would like someone with you. Some of the things you might read could be difficult and I want to check you have someone to support you.

If you're ready, let's start ...

When you were first born you lived in foster care with Sue and Bryan because Social Care were really worried that your birth mum Katie and your birth dad Shaun wouldn't be able to keep you safe and give you everything you need. To help make the right plan for you in the future, it was decided that a special assessment would be used to see if you could go back to live with Katie. You were nearly one at the time and that's when I first started working with you and Katie.

When I first became involved with your family, Katie and Shaun had separated and your Shaun had moved away. Katie told me she really wanted to look after you and that she really wanted to work hard to get you back. So the assessment began to see if she would be able to look after you safely now and in the future. The assessment looked at three different things; firstly it looked at everything you needed to be kept safe and well looked after in the future, secondly it looked at everything that had happened in Katie and Shaun's lives and thirdly it looked at whether Katie could overcome all her difficulties and give you everything you needed.

As part of the assessment everyone agreed you were a beautiful, healthy baby who loved to gurgle and had Katie's nose. Katie is very pretty, like you. Whenever I visited you, you were always very smiley – and I mean always. I remember one time when you had just woken up, and I expected you to be really drowsy and maybe a bit glum – and you were – for about 10 seconds! After that you were all smiles again! Because you were so little, you were completely dependent upon adults to meet all of your needs. It was decided that you needed to be somewhere safe and loving with a person who was able to understand what you needed and how to care for you for the rest of your childhood.

During the assessment we found out lots of things about Katie and Shaun's past. Sadly Shaun had not been looked after properly when he was little and he had seen lots of violence in his own family. When he grew up he had got into some fights himself and went to prison several times. We also found out that Katie suffered from something called depression which sometimes made her feel so sad it was a struggle to get out of bed.

Katie and Shaun met soon after he came out of prison and they would often argue. A number of times the police had to be called because Shaun had hurt Katie. When Katie found out she was pregnant, both Katie and Shaun were really pleased, as you were their first child. Unfortunately the arguments just got worse. The arguments also made Katie's depression worse and she stopped being able to leave the house. This was why Social Care first got involved with you and your family because they were worried you could get caught up in the violence and get hurt. Katie had also stopped leaving the house which meant she hadn't got any of the things she needed in preparation for you arriving. Things like a cot, baby bottles and clothes. As the violence was still

going on when you were born, a decision was made by the court that you should live in foster care and only see Katie and Shaun on planned visits in a place that was supervised by other adults.

Shortly after this happened, people tried to help Katie. She went to her doctor and got some medication that helped her depression, and she went to live in a refuge (a safe place) away from Shaun. This was really positive. Katie really wanted you back and she told me that every time I saw her. She never missed a single visit to you. I remember going to watch one visit and Katie brought you some bubbles. You loved watching them fly through the air and I had never seen Katie so happy.

Because Shaun had hurt Katie a lot in the past and there had been lots of arguments between them, one of the most important things Katie had to do was prove she could stay away from Shaun and keep you safe from him. As part of the assessment we had lots of conversations about what babies needed to be well looked after and the things that could harm them. At first Katie did really well. However things began to deteriorate, she started to arrive late when I was due to see her and on a few occasions she looked dirty and tired. One time I went to visit her, she wasn't at home in the refuge and no one knew where she was. As I couldn't find her I visited your Dad Shaun's home and I found her there. She told me she had left the refuge and gone to live with him. She had also stopped taking her medication for her depression. The house they were living in was very dirty and did not have any of the things a baby needed. After that the police received more reports of violence in the house and Katie stopped coming to see me.

Sadly this meant Katie and Shaun couldn't provide the safe, loving home that you needed for all of your childhood and this is what I had to write in assessment report. In fact the assessment said you would be at severe risk if you lived with them due to the arguments, violence and Katie and Shaun not having any of things they needed to look after you.

The court agreed with the assessment and although Katie was very sad, she wasn't able to show how she could look after you safely. It was decided at court that the best plan for you would be to look for other people to care for you for the rest of your childhood.

After that decision was made I had to stop working with you as the assessment had finished. But I wanted to make sure I got to write to you to help you to understand why I was involved in your life and why I made the decisions I did. At the time of me writing this letter you are still living with Sue and Bryan and I don't know where you are going to next. However I know that lots of people are thinking carefully about where you should live and the best plan for you. Sue and Bryan have just taken you on holiday camping and I have seen lots of photos and they are putting these in a special book for you which will go wherever you go. I hope you have that now.

By the time that you read this you will probably have some more questions about your birth family and why Social Care were involved in your life. If you want, and the time is right you can ask to see your files. If you decide to do this it might be a good idea to ask someone to go along with you to support you when you read them as it might be quite upsetting. That someone might be a really good friend, or a professional person, such as an advocate. Either way, it's definitely worth taking someone with you for support.

I really hope that you are always as happy as I remember you and I wish you all the very best in the future.

Best Wishes

Ruth (Social worker)

Annex 24

Case supervision for the Practice Framework

The importance of regular effective supervision for social workers has been widely acknowledged as crucial to keeping children safe. The following guidance is designed to inform the *additional* considerations that may be required alongside the local authority's supervision practice standards.

Managers who are supervising these cases need to be familiar with the Practice Framework and the underpinning evidence. They need to ensure that the components of essential practice listed on page 14 are completed for each case.

Assessment and decision-making (Stages 1 and 2)

The role of the supervisor will be to:

- Ensure an **analytical case history** is informing the work, ideally by allocating a **second worker** to do this.
- Establish/agree and monitor **timescales** and review the assessment to ensure that it is on target.
- Arrange **case supervision meetings** with the social worker and if possible, the worker who is producing the case history. If it is not possible to allocate a second worker, the manager should find another member of staff to review the evidence and provide some critique to the decision-making.
- Manage the case discussion and assist in the **identification of gaps** in information and how these will be addressed.
- Assist the social workers to **set tasks and goals** that are relevant to the assessment and specific case/situation.
- Facilitate **analysis** and allow staff time to discuss and **critically reflect** on the understanding they are forming of the family situation during the assessment.
- Ensure that a **flexible approach** is applied so that each assessment is tailored to the child and family.
- Ensure the assessment is informed by **objective and evidence-based** decision-making.
- Address **fidelity to the essential components** of the Framework, as set out on page 14.
- Explore **safeguarding** and ensure that a plan of action is identified to address any identified concerns.
- Produce a **record** of the key information and points from the supervision and include all **decision and actions**. It should be made clear who is responsible for these and the timescale/s for their completion.
- Ensure that the case team reach a **decision** about the risk classification, the potential for reunification and next steps.

Consideration should be given to the following within supervision:

- Ensuring that the **child's views and perspective** are central to the discussion and analysis
- Ensuring information is cross-referenced with: the **Practice Framework**; factors associated with future harm; the definitions of risk and protective factors
- Analysing the **strength of evidence** relating to parental capacity to change
- Assessing parental **capacity to change** in all areas that relate to parenting.
- Differentiating between **protective factors** that will alleviate risk and parental strengths
- The emerging **themes and patterns** identified in the assessment
- **Plans for permanence** if reunification will not take place
- The **impact of contact** with family members **on** the **judgment** and decision making of staff
- **Impact on staff** of communicating decisions to children and parents
- That the worker has **enough time** to undertake all the tasks expected.

Planning for reunification (Stages 3, 4 and 5)

Case supervision will continue between the team manager and the child's social worker and may now include key family support staff and their managers. Timescales for re-classifying the risk after a period of support and continued assessment should be agreed.

For those children who will return home, timescales for case monitoring and review should be agreed.

Supervision should consider:

- Parental agreements and goals: are they SMART?
- Appropriateness of support packages for children and parents
- Contingency plans if return home will not take place
- Accessibility and effectiveness of all services. Feedback to senior management and commissioners if there are issues.
- Views of the child
- Continuing assessment of risk – mitigating any misplaced optimism
- Plans for reunification
- Monitoring and review of reunification
- Legal status of child on return home
- Step down and case transfer/closure.

Find out more about our work at
[nspcc.org.uk](https://www.nspcc.org.uk)

2015